



INSTALLATION GUIDE v1.0

ENGLISH

CE declaration

We:

TerraTec Electronic GmbH, Herrenpfad 38, D-41334 Nettetal, Germany

hereby declare that the product:

TerraTec XLerate Pro

to which this declaration refers is in compliance with the following standards or standardizing documents:

1. EN 55022
2. EN 50082-1

The following are the stipulated operating conditions and environmental conditions for said compliance:

Residential, business and commercial environments and small-company environments.

This declaration is based on:

Test report(s) of the EMC testing laboratory

A handwritten signature in black ink, appearing to be 'H. ...', located below the text 'Test report(s) of the EMC testing laboratory'.

TerraTec® ProMedia, SoundSystem Gold, SoundSystem Maestro, SoundSystem Base 1, AudioSystem EWS®64, XLerate, Wave-System, MIDI Smart and MIDI Master Pro are Trademarks of TerraTec® Electronic GmbH Nettetal.

In most cases, the designations used in this handbook for software and hardware are also registered trademarks and are thus subject to the relevant regulations.

©TerraTec® Electronic GmbH, 1994-1999. All rights reserved 0.30.04.99

Meticulous care has been exercised in the preparation of all text passages and illustrations in this User Guide. TerraTec Electronic GmbH and its authors, however, accept no liability, legal or otherwise, for errors or the consequences of such errors. We reserve the right to technical modifications.

All text passages in this documentation are copyrighted. All rights reserved. No part of this documentation may be reproduced in any form whatsoever, by photography, microfilming or other process or rendered into a language/form usable by computers without the prior, written consent of the authors. All rights for use and propagation by presentation, radio and television are also reserved.

CONTENTS

Preface	5
TerraTec XLerate Pro.	5
Introduction	6
TerraTec XLerate Pro.	6
Connections.	8
Technical data.	9
Installing the sound card	11
Driver installation.	14
Windows 95a or OSR1	14
Windows 95 OSR2.	18
Windows 98.	24
Uninstalling the drivers under Windows 95/98	29
Windows NT 4.0. (Service Pack 3 or higher)	31
Installation of the bundle software	34
Manually	34
Automatically using the XLerate Pro Autostarter	35
Connecting external periphery	36
Connecting speakers / headphones.	36
Setting up the speakers for an optimal A3D acoustic image	36
Connecting a microphone.	37
Connecting an external audio source.	37
Connecting a digital audio source.	37
MIDI port	38
Connecting the joystick	38
CD-ROM audio connector.	39
TAD connector	39
Aux connector	39

Connecting upgrade cards	40
Connecting a wavetable module	40
Expansion connector	40
The XLerate Pro ControlPanel.	41
Configuring the XLerate Control Panel	41
Starting and exiting the XLerate Pro Control Panel	42
Control Panel tabs	44
The graphic equalizer	45
MIDI tab	46
A3D Settings tab	47
A3D Demos tab	48
Digital Out tab	48
The Mixer	49
Legacy audio configuration	52
Configuring the MIDI port address manually	55
Manual configuration of the gameport address	56
Appendix	58
Wavetable Instrument Table	58
Wavetable percussion table	59
MIDI implementation chart	60
Switching of the MIDI interface	61
The TerraTec hotline	62
TerraTec service	64
General terms of service	66

PREFACE

TERRATEC XLERATE PRO.

CONGRATULATIONS

on your decision to buy a TerraTec sound card - and join the steadily growing group of quality-conscious multimedia users. You have made the right choice, and you will find that this User Guide contains the information you need to get your TerraTec XLerate Pro up and running in the shortest possible time. We know that no-one enjoys ploughing through manuals (we certainly don't ☺), so a quick-reference guide has been included for experienced users. Remember, though, that it might be worthwhile glancing through the rest of the User Guide, particularly if you run into difficulties or if a problem arises, or simply if you would like some background facts and figures. You never know what useful snippets of information you might find.

Enjoy your TerraTec XLerate Pro!

Your TerraTec Team

INTRODUCTION

TERRATEC XLERATE PRO.

THE A3D™ CULT CARD FOR PRO GAMERS.

The TerraTec XLerate™Pro delivers a range of exciting features and functions that set new standards—especially in the 3D Audio sector—and which are guaranteed to thrill you. Keep those ears wide open.

With its Aureal Vortex 2 PCI audio chip, the card provides full hardware support for A3D 2.0 and DirectSound™/3D, reducing the CPU load and liberating extra power for swift, smooth gaming.

A3D™2.0 POSITIONAL 3D AUDIO.

A3D™2.0 can handle up to 16 simultaneous audio sources that can be spatially positioned as required. What's more, Wavetracing™ can calculate up to 64 reflections in real time for realistic environmental sound modeling. The position of the listener, the geometry of the surroundings and the reflective characteristics of a variety of materials are all taken into consideration. Thanks to Wavetracing™, a gunshot sounds completely different in a closed room than it would outdoors, for example.

Over 100 titles have already been published or are currently being developed for A3D™ 1.0 or A3D™2.0. These include such hits as StarSiege, Half-Life, Unreal, Motorhead, Recoil and Tomb Raider III.

A complete list of all games that support A3D™ as well as additional information on A3D™ can be found at www.a3d.com.

SOUND VIA 2 OR 4 SPEAKERS.

But that's not all. The XLerate Pro supports audio output via headphones, two or even four speakers. The speaker configuration can be set up easily and intuitively with the XLerate Pro ControlPanel to ensure the best possible audio playback in applications that support A3D™ or DirectSound™3D. This permits the use of algorithms specifically developed for this type of output. The final touches can be added using the graphic 10-band stereo equalizer.

32-44.1-48: The parameters of the digital output are really something to hear. They ensure that your XLerate Pro will quickly make contact—to your MiniDisc or DAT recorder for example—without losses, of course.

320 VOICES.

The integrated wavetable synthesizer satisfies even the most discriminating listeners. A high-quality 4 MB sample set provides the perfect setting for your MIDI music—including 320 solid voices and an effects processor!

The wavetable is also available in Windows 95/98 DOS boxes to ensure that you don't have to miss out on powerful MIDI sound in your DOS games. The XLerate Pro supports the Downloadable Samples Standard (DLS 1.0) so that you can replace the included 4 MB sample set with samples of your own. The ultimate in sound versatility.

And if that's still not enough, upgrade the XLerate Pro with a wavetable daughterboard.

Thanks to its SoundBlaster™Pro compatibility, classic games also run in real-DOS mode without problems. The XLerate Pro gameport is designed for analog as well as digital joysticks, and will even team up with Force Feedback joysticks.

CONNECTIONS.

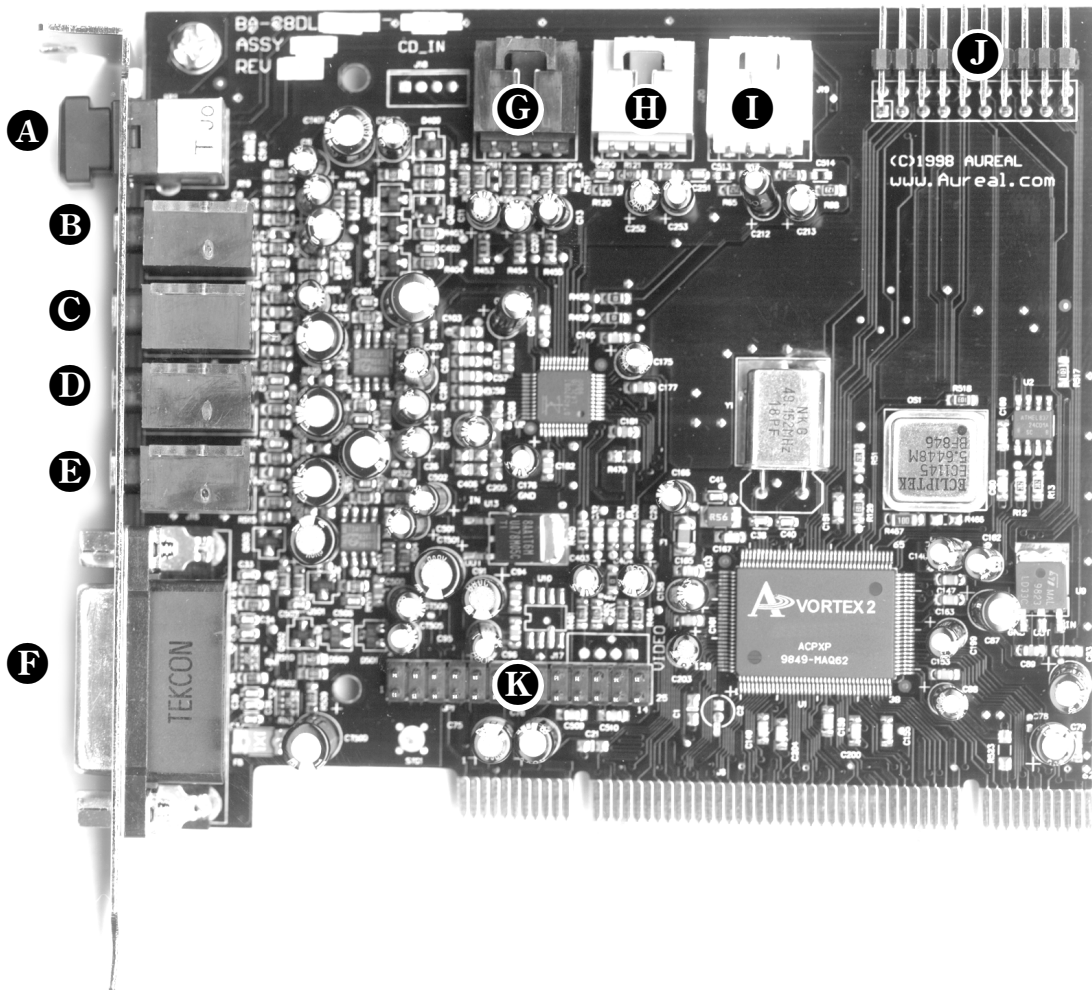

- A** Digital OUT (TOS-Link)
- B** Line IN
- C** Mic IN
- D** Line OUT 1
- E** Line Out 2
- F** MIDI / Joystick interface
- G** CD audio connector MPC3 (black: Left - ground - ground - Right)
- H** TAD connector (green: Mono In - ground - ground - Mono Out)
- I** Aux In (white: Left - ground - ground - Right)
- J** Expansion connector
- K** Wavetable connector

TECHNICAL DATA.

AT A GLANCE.

- A3D 2.0™ 3D audio with 16 3D sources and up to 64 3D reflections
- Up to 96 DirectSound™ hardware buffers
- DirectSound™3D hardware acceleration
- 2 Line-outs, stereo
- 320-voice DLS wavetable synthesizer with 2 x 8 effects
- Optical digital output (32 kHz/44.1 kHz/48 kHz; S/PDIF)
- Graphic 10-band stereo equalizer
- SoundBlaster™ Pro compatible
- 18-bit A/D-D/A converter
- Signal-to-noise ratio > 97dB (A-A, A-weighted)

COMPATIBILITY

- A3D 1.0™, A3D 2.0™
- Microsoft® DirectSound™
- Microsoft® DirectSound™3D
- DLS 1.0
- General MIDI
- MPU-401™
- SoundBlaster™Pro
- AC'97 v2.1
- PC 98
- PCI 2.2, PCI 2.1

DIGITAL AUDIO.

- A3D 2.0 3D-Audio, downwards compatibility to A3D 1.0
- A3D 2.0 Wavetracing engine with up to 64 reflections
- 8/16-bit audio stereo/mono for recording and playback with 48 kHz
- Extended full duplex stereo recording and playback (mono/stereo)
- Optical digital output at 32 kHz, 44.1 kHz and 48kHz (S/PDIF)
- Hardware-based sample-rate conversion

WAVETABLE SYNTHESIZER.

- Up to 320 voices (64 hardware, 256 software)
- DLS 1.0 compatible
- 2-channel effects processing with 8 effects each
- High-quality 4 MB general MIDI sample set

AUDIO MIXER.

- Individual level controls for all audio sources
- Graphic 10-band stereo equalizer

MIDI/JOYSTICK INTERFACE.

- MPU-401™ compatible
- Soundblaster MIDI interface
- DirectInput™ Acceleration
- Analog/digital joystick interface

EXTERNAL CONNECTIONS.

- 2 line-outs (stereo, 3.5 mm jack)
- 1 optical digital output (TOS link)
- 1 line-in (stereo, 3.5 mm jack)
- 1 microphone input (mono, 3.5 mm jack)
- MIDI/joystick interface (IBM 15-pin Sub-D)

ONBOARD CONNECTIONS.

- CD audio (MPC3)
- AUX input (MPC3)
- TAD connector (MPC3)
- WaveBlaster pin-compatible connection (for wavetable daughterboards)
- Expansion connector

DRIVERS.

- MS-DOS® 7.0
- Windows® 95/98
- Windows® NT 4.0

SYSTEM REQUIREMENTS

- One free PCI 2.1-compatible PCI slot
- Intel® Pentium™166 MMX™ or better
- Min. 16 MB RAM, 32 MB RAM recommended
- CD-ROM drive (to install the drivers and software)
- Min. 15 MB free hard disk space
- Active speakers or headphones
- Windows® 95/98 with DirectX™5.0 or higher,
or Windows® NT 4.0 with ServicePack 3 or higher

INSTALLING THE SOUND CARD

Before installing the sound card, please take note of any special points pertaining to the configuration of your computer. Also refer to the handbook of your computer and other expansion cards for their settings.

Please observe the following instructions to ensure a trouble-free installation.

If difficulties arise nevertheless, please reread the relevant chapter in this handbook carefully.

Please call our service hotline if you are still having problems. The phone numbers and hours of the hotline can be found in the Appendix of this documentation.

Start by making sure that nothing is missing.

You should have received:

- 1 TerraTec XLerate Pro sound card
- 1 Driver & Installation CD
- 1 Quick reference
- 1 audio cable (mini-jack to cinch)
- 1 registration card with the serial number

Return the registration card to us at the earliest possible opportunity or register online at www.terratec.de/register.htm. This is important for support and hotline services.

WARNING!

Before opening the case, unplug the mains cable from the wall socket as well as from the PC.

ESD (electrostatic discharge) may damage disk drives, add-on boards and other components. The steps described should only be carried out at an ESD workstation. If one is not available, you can prevent electrostatic discharge by wearing an antistatic arm band and holding it to a metal part of the system housing.

Please note that opening the housing in no way breaches the conditions of guarantee provided that you do not carry out any modifications to the hardware components inside. Any unauthorized expansion of the PC may however affect your rights under the terms of the guarantee. Any such work should be discussed beforehand with your specialist dealer.

Now it's time to arm yourself with a Phillips screwdriver.

And here's what to do, step by step:

- Switch off your PC and all connected periphery, in other words printer, monitor and so on. Leave the AC cord connected for the time being, so that your computer is still grounded.
- Touch the metal chassis at the rear of the PC to ground yourself and discharge static. Now unplug the cord from the AC mains socket.
- Remove the cover from the case of your PC.
- Look for a free PCI expansion slot, remove the screw holding the slot blanking plate and remove the plate. To ensure the optimal function of your sound card, look for an expansion slot that is not immediately next to an already-installed card. Some cards, such as video adapters, can send out signals which can interfere with the sound card.
- Carefully remove the sound card from its packaging and pick it up by the edges with one hand while your other hand is resting on the metal of the PC case.
- This will ensure that your body is completely discharged via your computer without affecting the sound card. Do not touch the components of the card under any circumstances.
- Align the holder at the rear of the sound card in the expansion slot in such a way that the card's gold-colored connectors are directly in line with the slot's socket.

- Carefully seat the card in the slot. You might have to press the card firmly into the slot to make a good contact. Take care to ensure that the contacts are precisely in line, in order to avoid damaging the sound card or the motherboard in your PC.
- Insert and tighten the screw from the slot cover to secure the sound card in its slot.
- Connect the CD-ROM drive to the sound card with the audio cable. (In general, this cable is provided with the CD-ROM drive). (Please also read chapter *Connecting external periphery* on [page 36](#)).
- Reinstall the cover of your PC case.
- Connect your speakers or hifi stereo system to the sound card (Please also read chapter *Connecting external periphery* on [page 36](#)). Positioning your speakers for an optimal A3D acoustic image is also covered in the chapter *Connecting external periphery*. ([page 36](#))
- Reconnect the mains and all other cables. Make sure that your speakers or hifi system is set to low volume. Start your computer.
- Please continue with the chapter *Driver installation* ([page 14](#)) .

DRIVER INSTALLATION.

PREFACE

In the following driver installation instructions, the <CD> stands for the drive letter assigned to your CD-ROM drive. If you have more than one CD-ROM drive, please use the letter of the drive containing the ***XLerate Pro Driver & Installation CD***.

WINDOWS 95A OR OSR1

NOTE: In the event that DirectX 5.0 or higher is not present on your computer, the driver installation will be interrupted and the DirectX installation will start automatically. If the automatic installation does not work for some reason, you will be prompted for the folder containing the DirectX setup program. Enter <CD>:\DirectX\Setup.exe and click **OK**.

The TerraTec XLerate Pro driver installation will continue after the DirectX installation is complete and the computer has restarted.

After you have installed the card, insert the ***XLerate Pro Software & Driver CD*** into your CD-ROM drive and start Windows 95.

The following screen will appear.

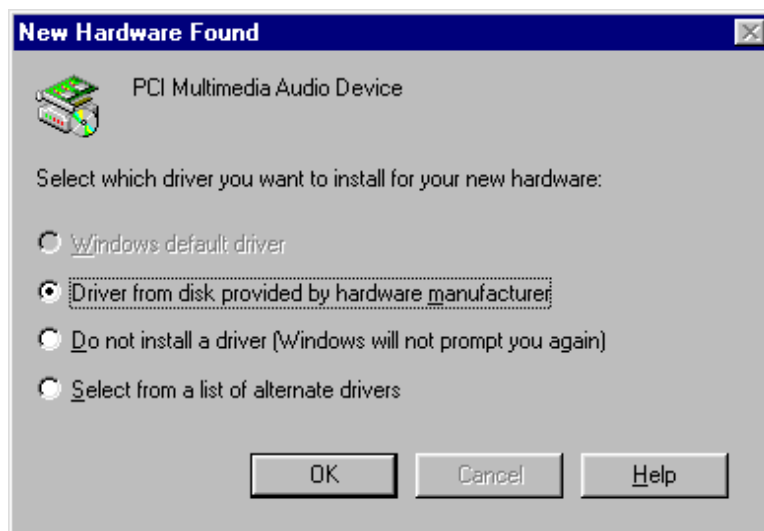

Select ***Driver from disk provided by hardware manufacturer*** and click **OK**.

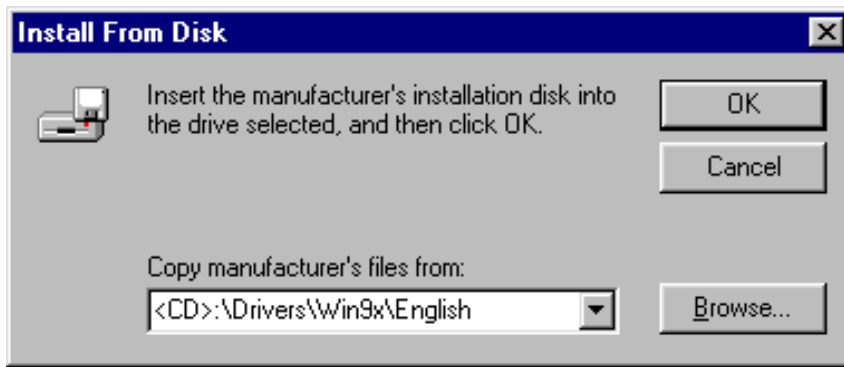

Type the path <CD>:\Drivers\Win9x\English and click **OK**, or click **Browse** to locate the correct folder using the mouse.

If you selected **Browse**, switch to your CD-ROM drive in the following window. Next, switch to the folder <CD>:\Drivers\Win9x\English and click **OK**.

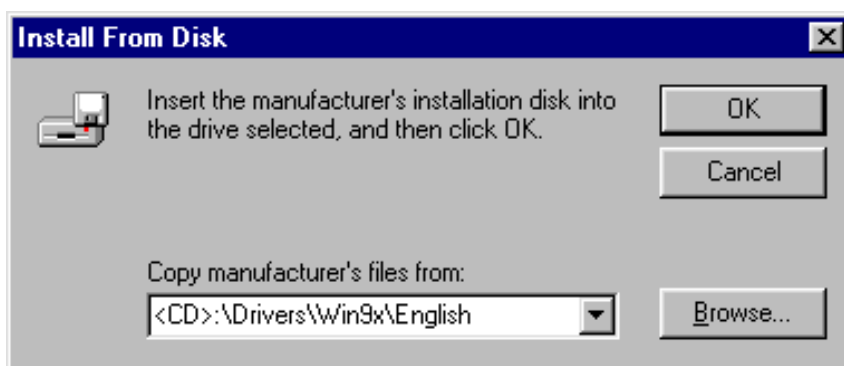
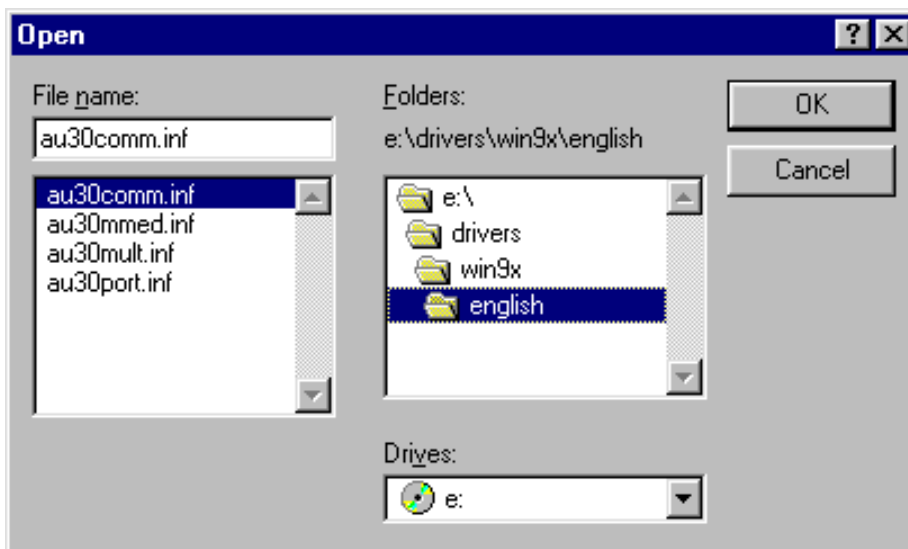

Confirm the path by clicking **OK**.

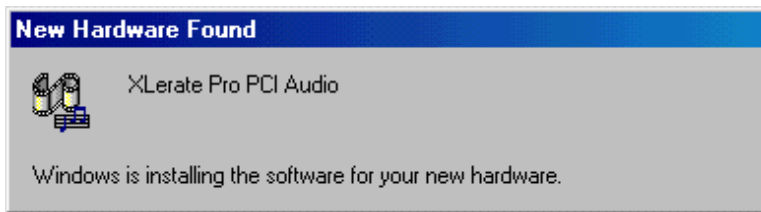

After the drivers for the card have been installed, the drivers for the gameport are next...

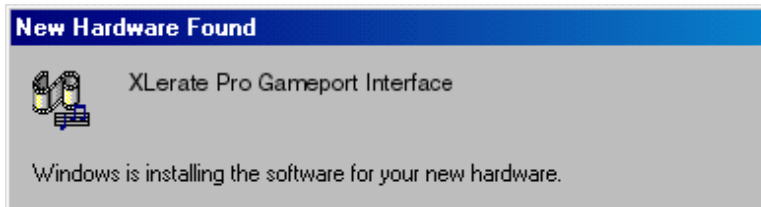

followed by the MPU-401 interface...

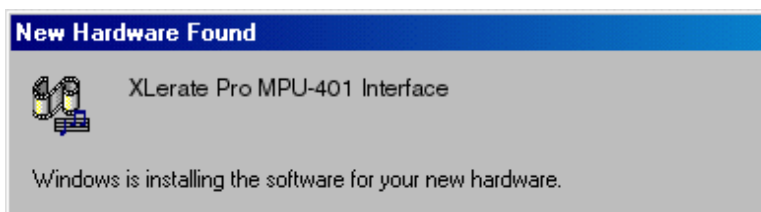

and finally the SoundBlaster emulation.

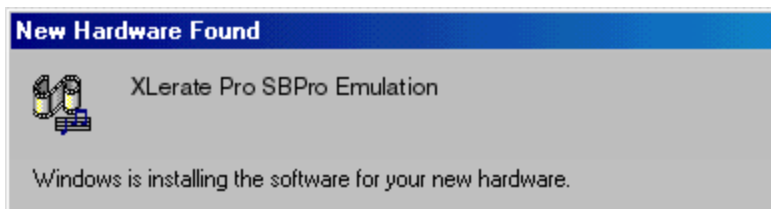

The A3D demos are installed automatically during the driver installation. If this automatic installation fails for any reason, start the program `setup.exe` in the `<CD> : \A3D\A3DDEMOS` folder.

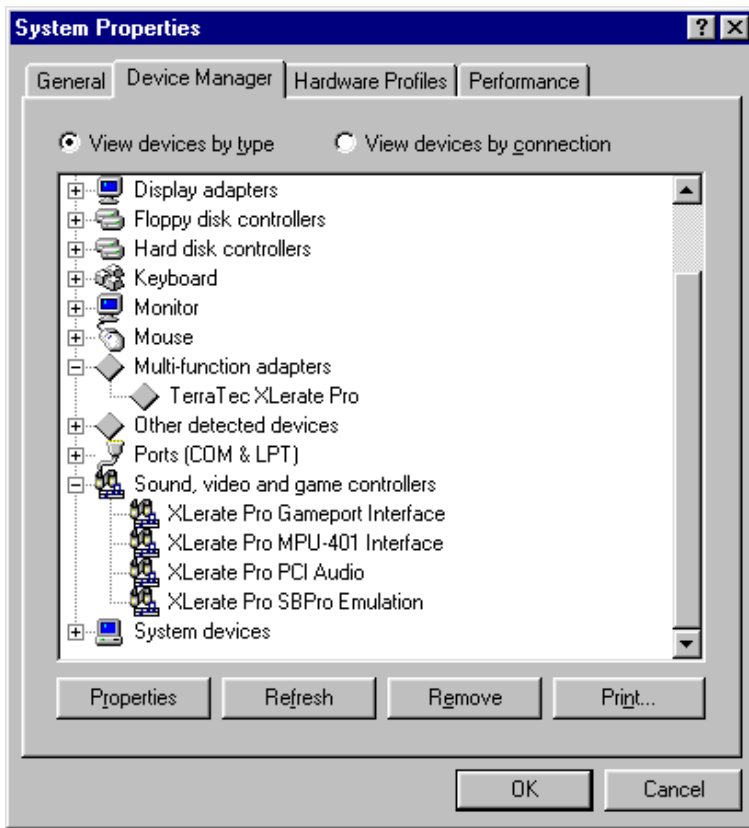

The sound card should be listed in the Device Manager after the drivers have been successfully installed.

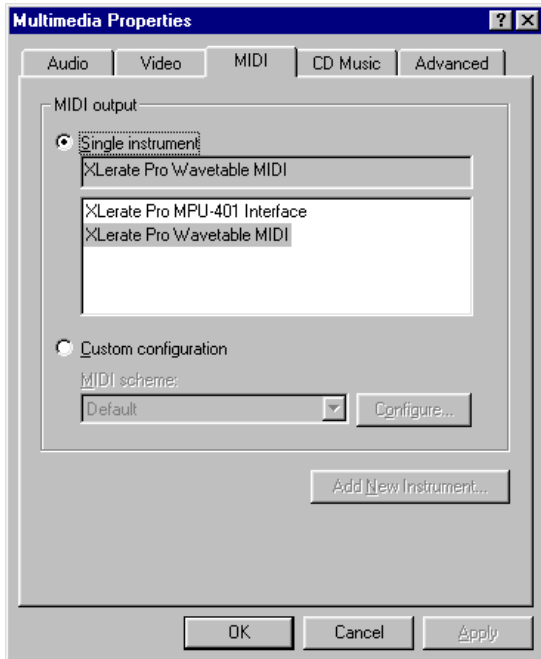

Next, check the MIDI settings.

Open the control panel and double-click **Multimedia**. Go to the **MIDI** tab.

If you do not have an external wavetable or wavetable daughterboard, please ensure that the **XLerate Pro Wavetable MIDI** entry is active, not **XLerate Pro MPU-401 Interface**.

If you have an external wavetable or wavetable daughterboard installed, use this window to set the MIDI output to suit your requirements.

WINDOWS 95 OSR2.

NOTE: In the event that DirectX 5.0 or higher is not present on your computer, the driver installation will be interrupted and the DirectX installation will start automatically. If the automatic installation does not work for some reason, you will be prompted for the folder containing the DirectX setup program. Enter <CD>:\DirectX\Setup.exe and click **OK**.

The TerraTec XRate Pro driver installation will continue after the DirectX installation is complete and the computer has restarted.

After you have installed the card, insert the **XRate Pro Software & Driver CD** into your CD-ROM drive and start Windows 95.

The following screen will appear.

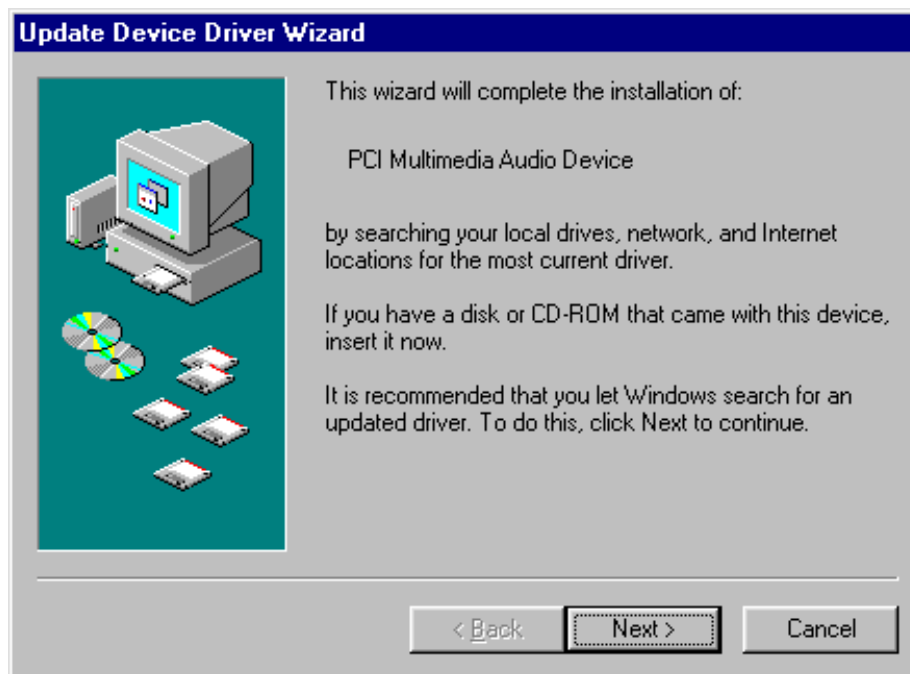

Click on **Next** with the left mouse button.

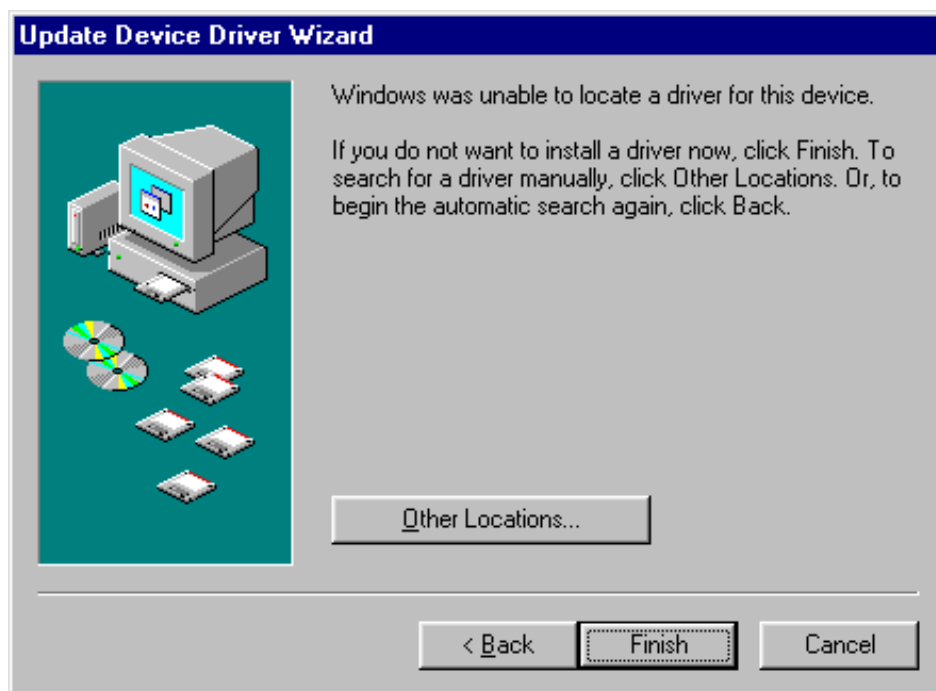

Click on **Other Locations**.



Type the path `<CD>:\Drivers\Win9x\English` and click **OK**, or click **Browse** to locate the correct folder using the mouse.

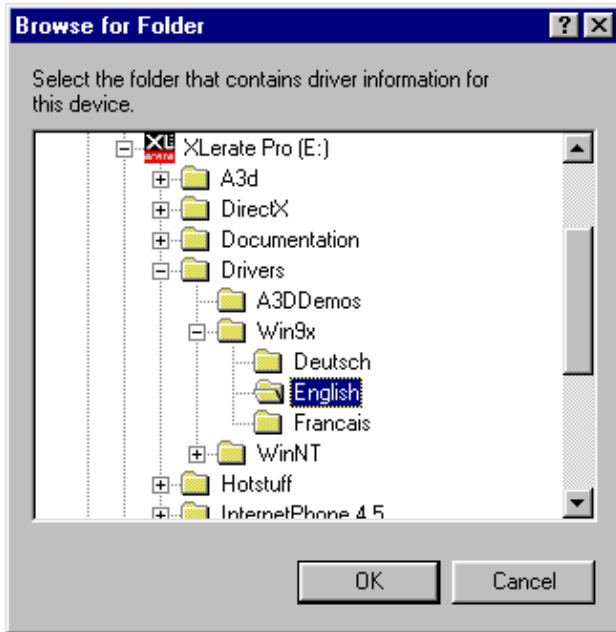

If you selected **Browse**, switch over to the folder
<CD>:\Drivers\Win9x\English on
your CD-ROM drive in the following win-
dow. Click on **OK**.

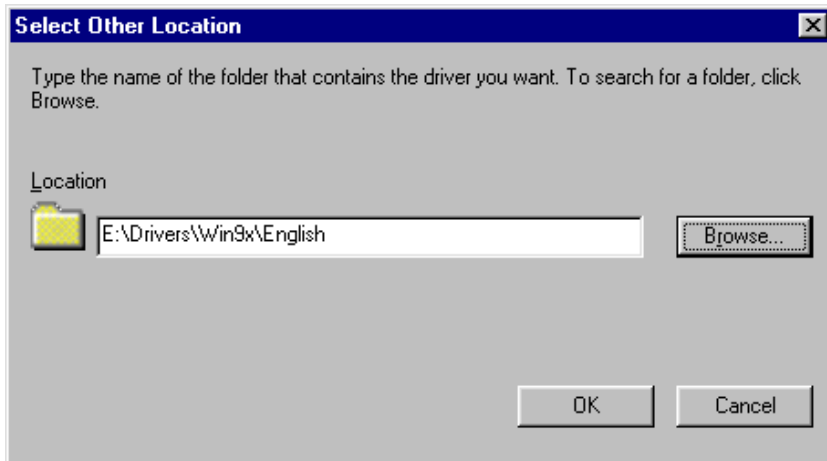

Confirm the path by click-
ing **OK**.



Click on **Next** to install
the drivers for the
TerraTec XLerate Pro.

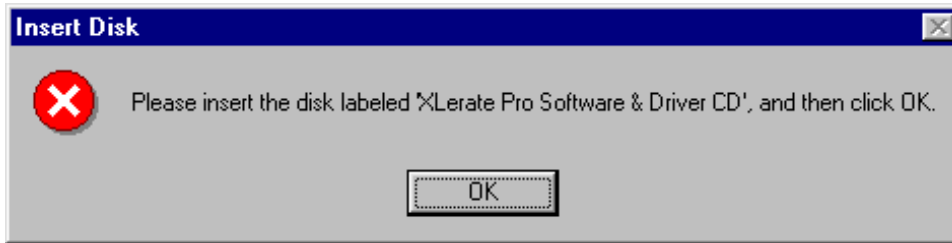

Click on **OK**.

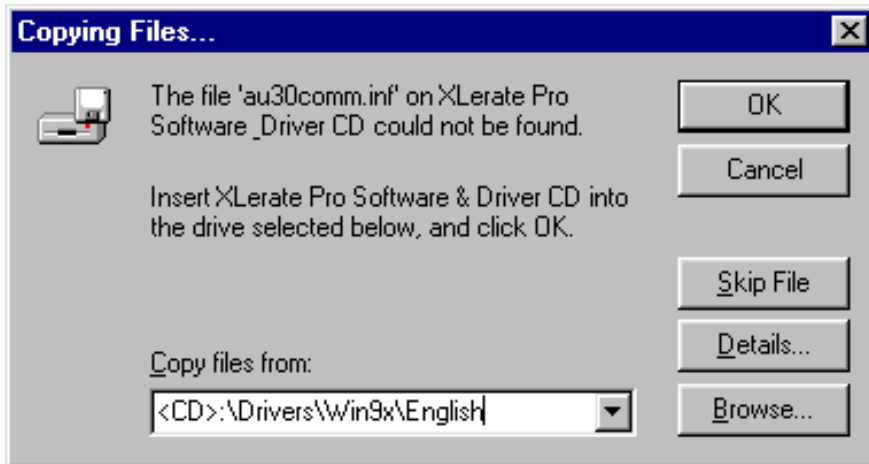

Type the path <CD>:\Drivers\Win9x\English and click **OK**, or click **Browse** to locate the correct folder using the mouse.

If you selected **Browse**, switch over to the folder <CD>:\Drivers\Win9x\English on your CD-ROM drive in the following window.

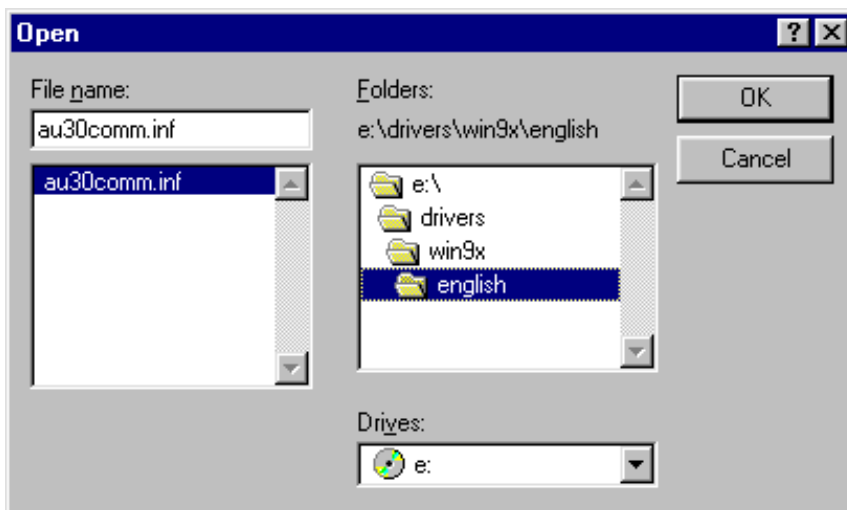

Click on **OK**.

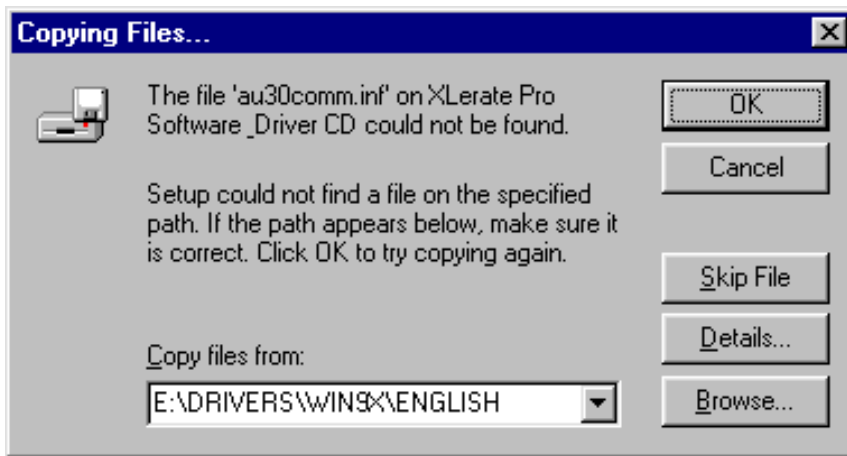

Confirm the path by clicking **OK**.

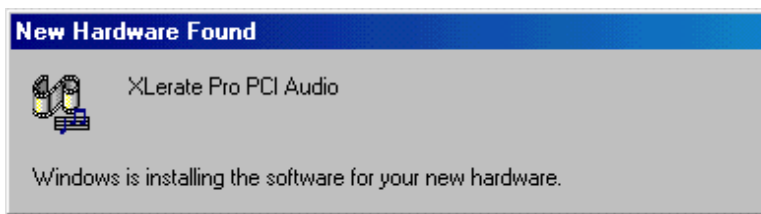

After the drivers for the card have been installed, the drivers for the gameport are next...

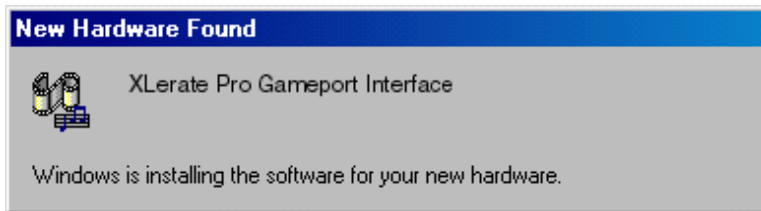

followed by the MPU-401 interface...

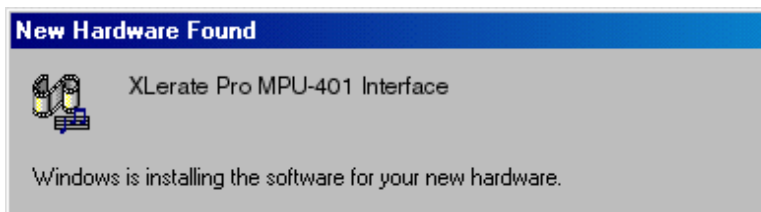

and finally the SoundBlaster emulation.

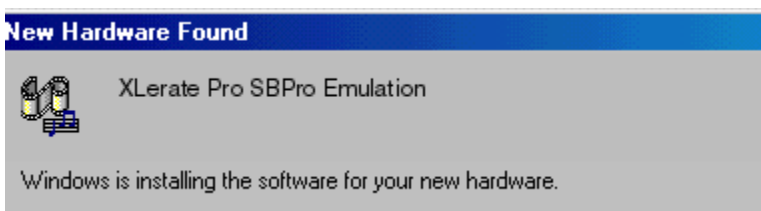

The A3D demos are installed automatically during the driver installation. If this automatic installation fails for any reason, start the program `Setup.exe` in the `<CD> : \A3D\A3DDEMOS` folder.

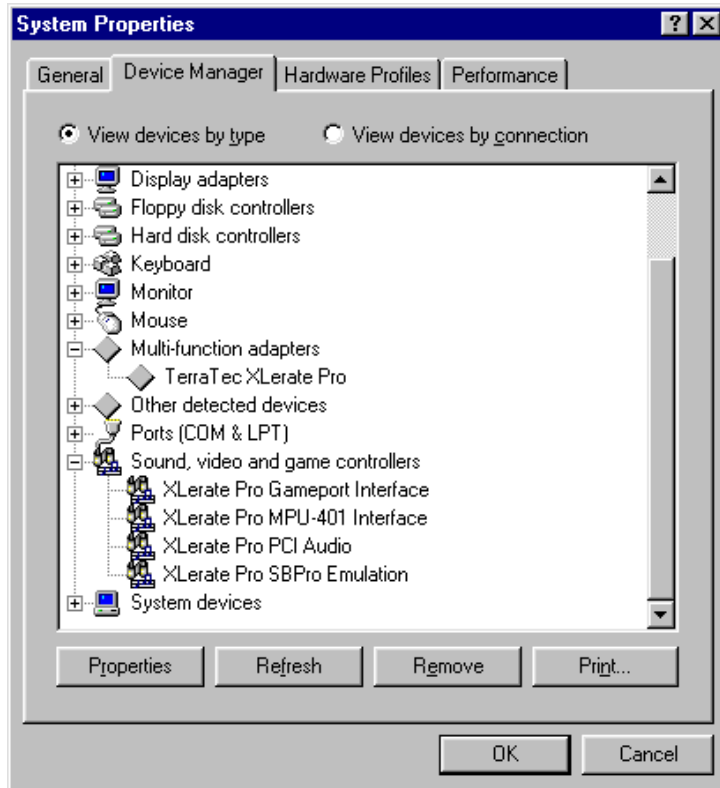

The sound card should be listed in the Device Manager after the drivers have been successfully installed.

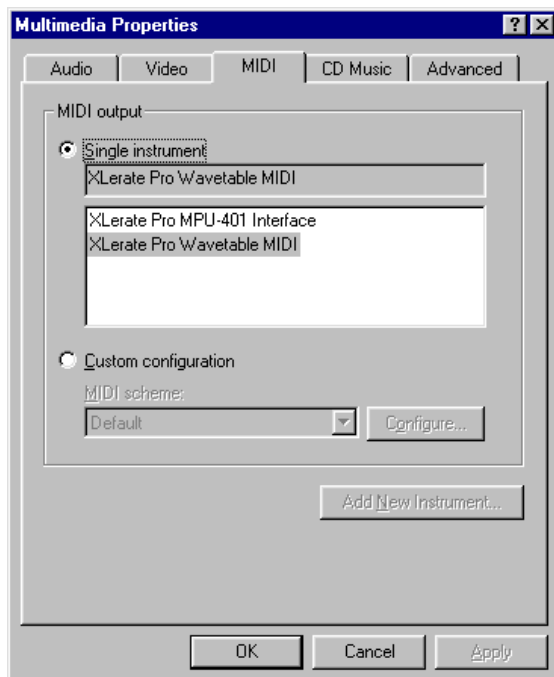

Next, check the MIDI settings.

Open the control panel and double-click **Multimedia**. Go to the **MIDI** tab.

If you do not have an external wavetable or wavetable daughterboard, please ensure that the **XLerate Pro Wavetable MIDI** entry is active, not **XLerate Pro MPU-401 Interface**.

If you have an external wavetable or wavetable daughterboard installed, use this window to set the MIDI output to suit your requirements.

WINDOWS 98.

After you have installed the card, insert the ***XLerate Pro Software & Driver CD*** into your CD-ROM drive and start Windows 98.

The following screen will appear.



Click on ***Next*** with the left mouse button.

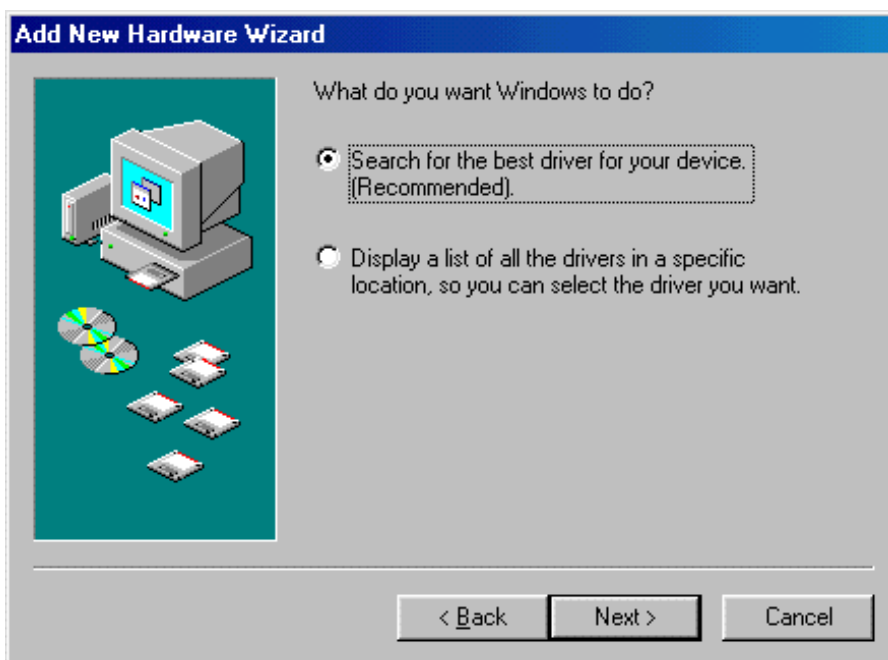

Choose ***Search for the best driver for your device (recommended)*** and click ***Continue***.

Type the path <CD>:\Drivers\Win9x\English and click **OK**, or click **Browse** to locate



the correct folder using the mouse.

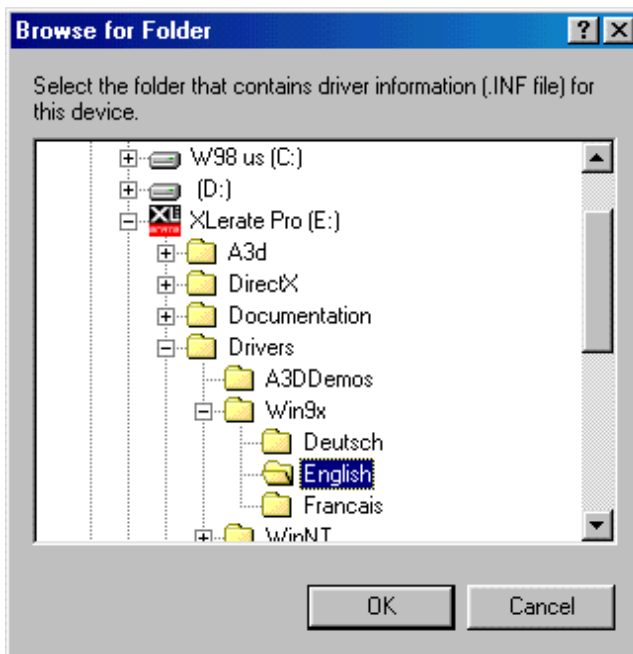

If you selected **Browse**, switch over to the folder

<CD>:\Drivers\Win9x\English on your CD-ROM drive in the following window. Click on **OK**.



Confirm the path by clicking **OK**.



Click on **Next** to install the drivers for the TerraTec XLe-rate Pro.

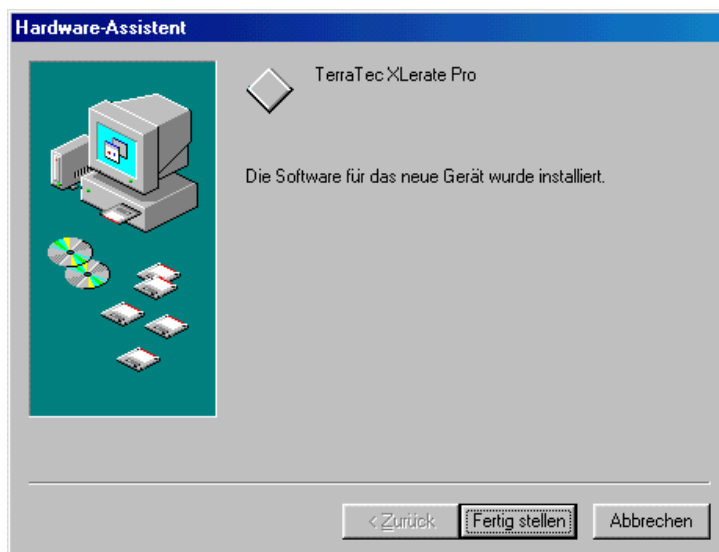

Click here on **Finish**.

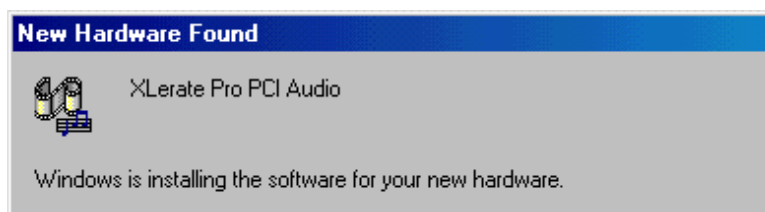

After the drivers for the card have been installed, the drivers for the gameport are next...

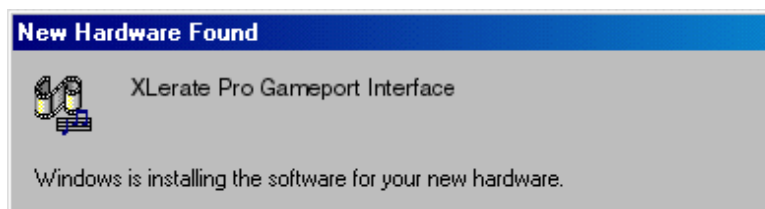

followed by the MPU-401 interface...



and finally the SoundBlaster emulation.

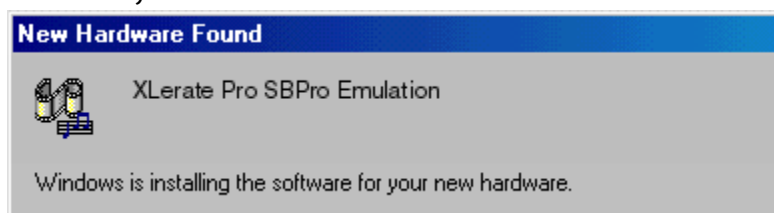

The A3D demos are installed automatically during the driver installation. If this automatic installation fails for any reason, start the program `setup.exe` in the `<CD> : \A3D\A3DDEMOS` folder.

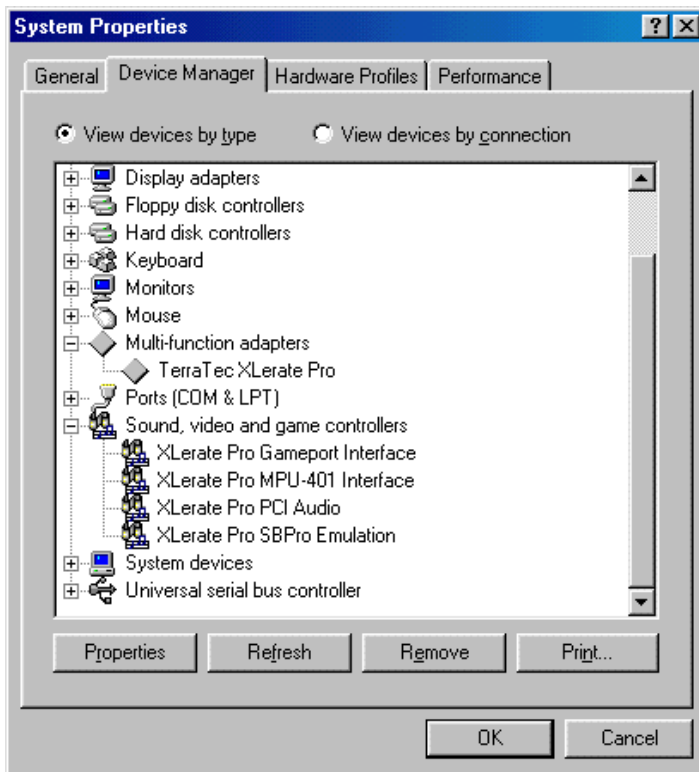

The sound card should be listed in the Device Manager after the drivers have been successfully installed.

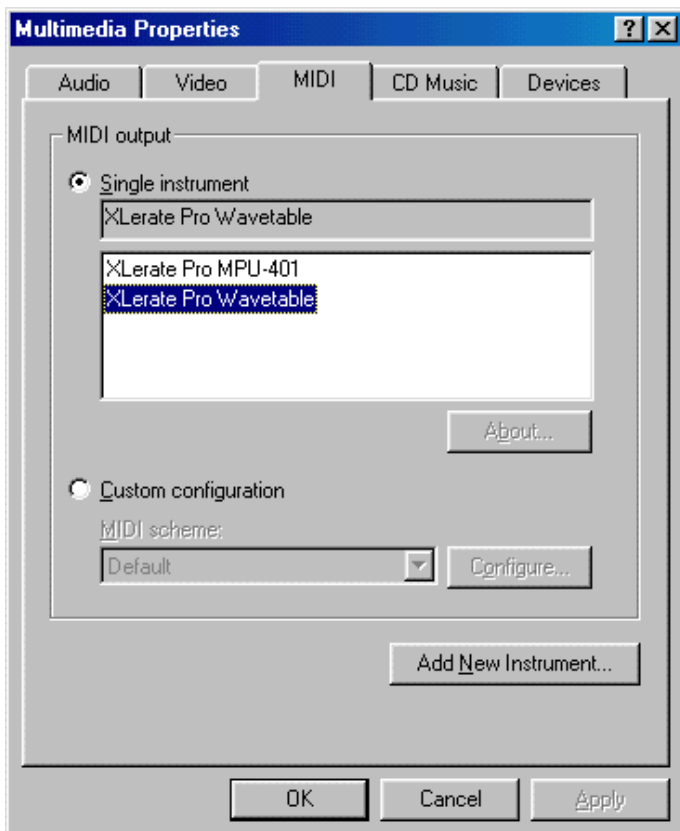

Next, check the MIDI settings. Open the control panel and double-click **Multimedia**. Go to the **MIDI** tab.

If you do not have an external wavetable or wavetable daughterboard, please ensure that the **XLerate Pro Wavetable MIDI** entry is active, not **XLerate Pro MPU-401 Interface**.

If you have an external wavetable or wavetable daughterboard installed, use this window to set the MIDI output to suit your requirements.

UNINSTALLING THE DRIVERS UNDER WINDOWS 95/98

Should it ever be necessary to uninstall the XLerate Pro drivers, proceed as follows, the procedure is identical for Windows 95a, Windows 95b and Windows 98.

Open the Control Panel, for example by



Double-clicking on **My Computer** with the left mouse button. Open the **System Properties** window and select the **Device Manager** tab.

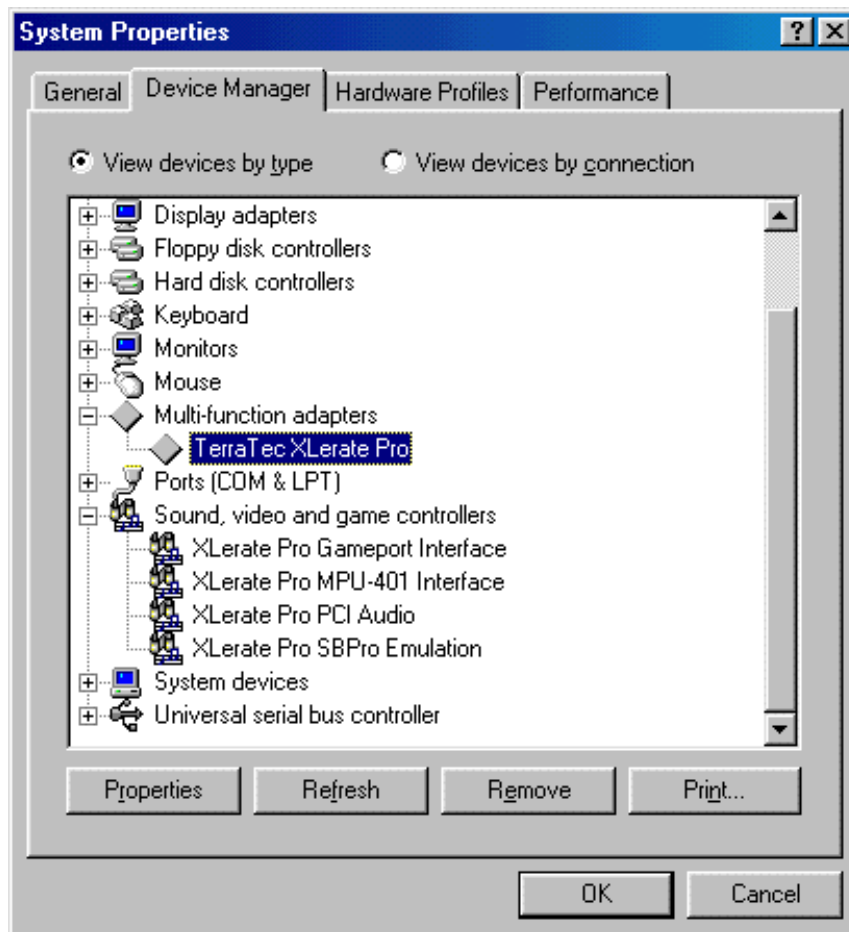

Click on the plus sign in front of the device category **Multi-function cards** and mark the **TerraTec XLerate Pro** entry with a second click.

Next, click on **Remove** and confirm the following question regarding the removal of the device from the system configuration with **OK**.

Once the device has been successfully removed, please click on **Close**.

Next, please click on **Add/Remove Programs** in the **Control Panel**. On the **Install/Uninstall** tab, select the **XLerate Pro Driver** entry from the list of programs and drivers and click **Add/Remove**.

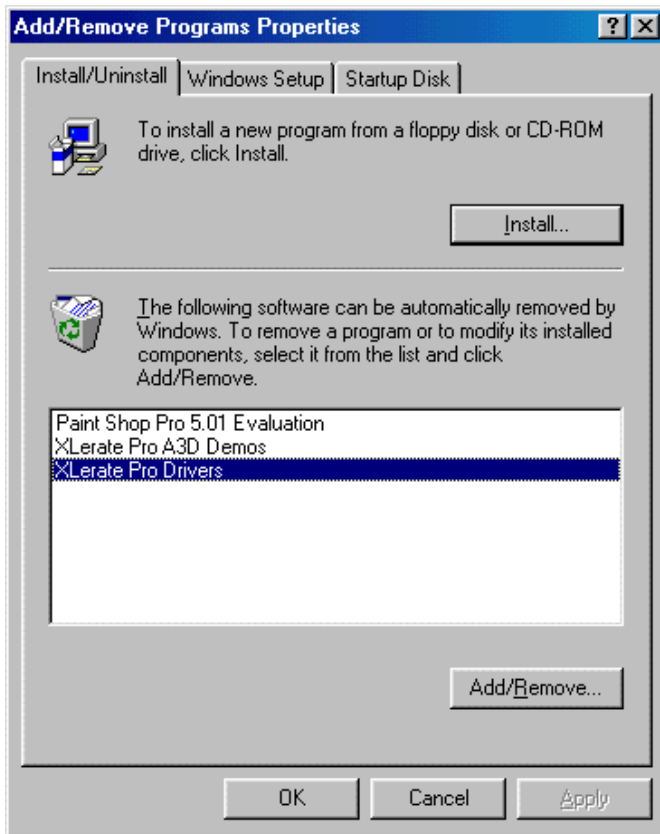

Select **Uninstall XLerate Pro** to remove the drivers and other XLerate components from your system.

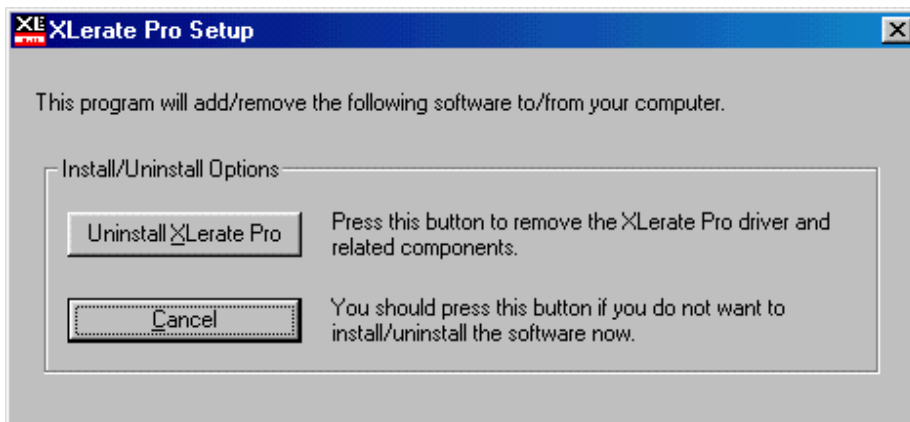

Finally, click on **OK** to complete the removal of the XLerate Pro with its associated drivers and other components.

WINDOWS NT 4.0. (SERVICE PACK 3 OR HIGHER)

Please ensure that you are logged on as Administrator when installing the drivers.

Please select:



Next, double-click Multimedia.

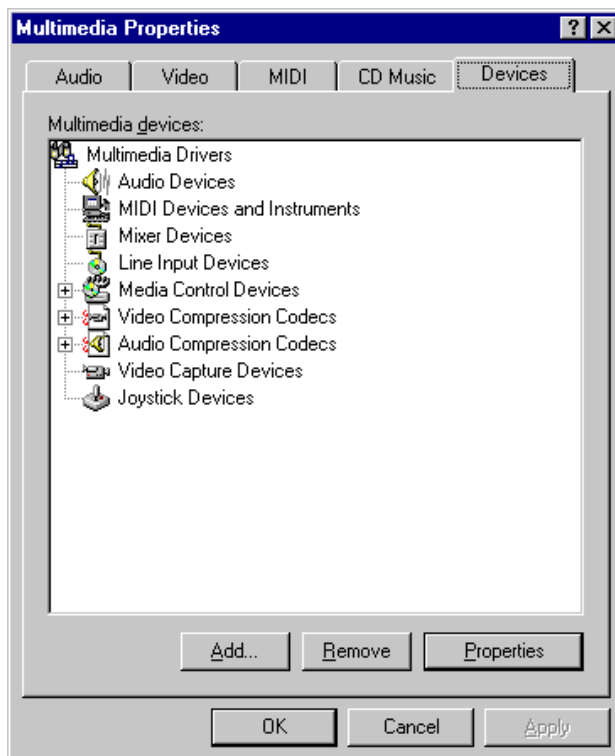

In the **Multimedia Properties** window, go to the **Devices** tab and click **Add**.

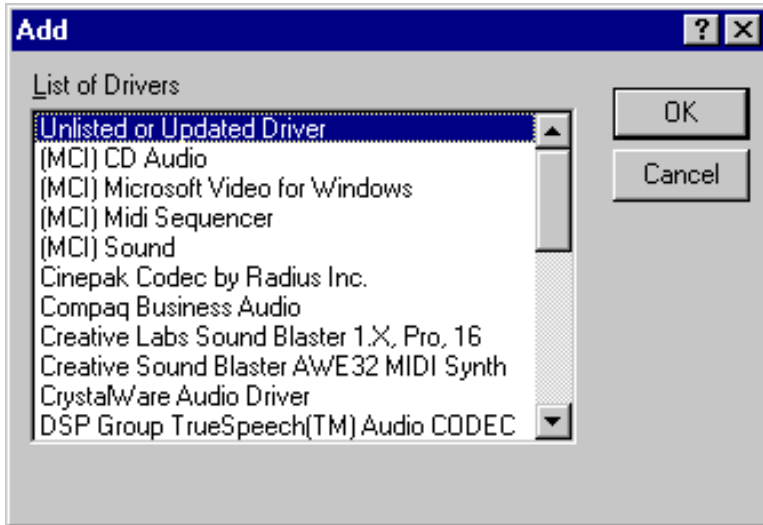

Select **Unlisted or Updated Driver** and click **OK**.

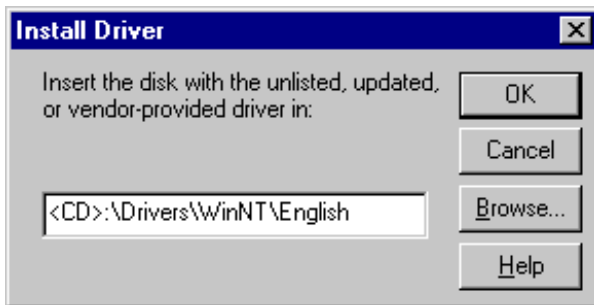

Type the path `<CD>:\Drivers\WinNT\English` and click **OK**, or click **Browse** to locate the correct folder using the mouse.



If you selected **Browse**, switch over to the folder `<CD>:\Drivers\WinNT\English` on your CD-ROM drive in the following window.

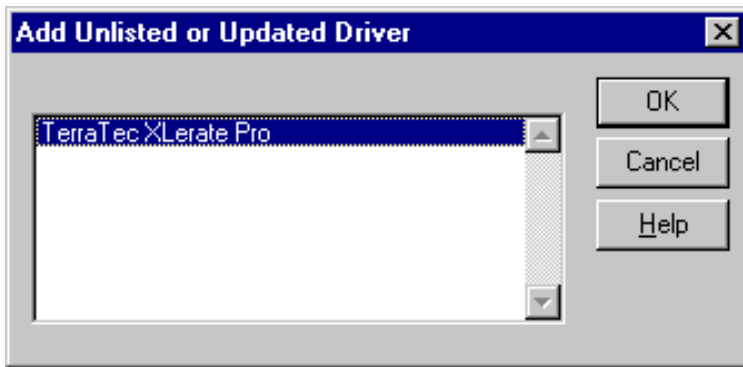

Choose the entry **TerraTec XLerate Pro** and click **OK**.

Confirm that you would like to install the drivers once again in the next window.

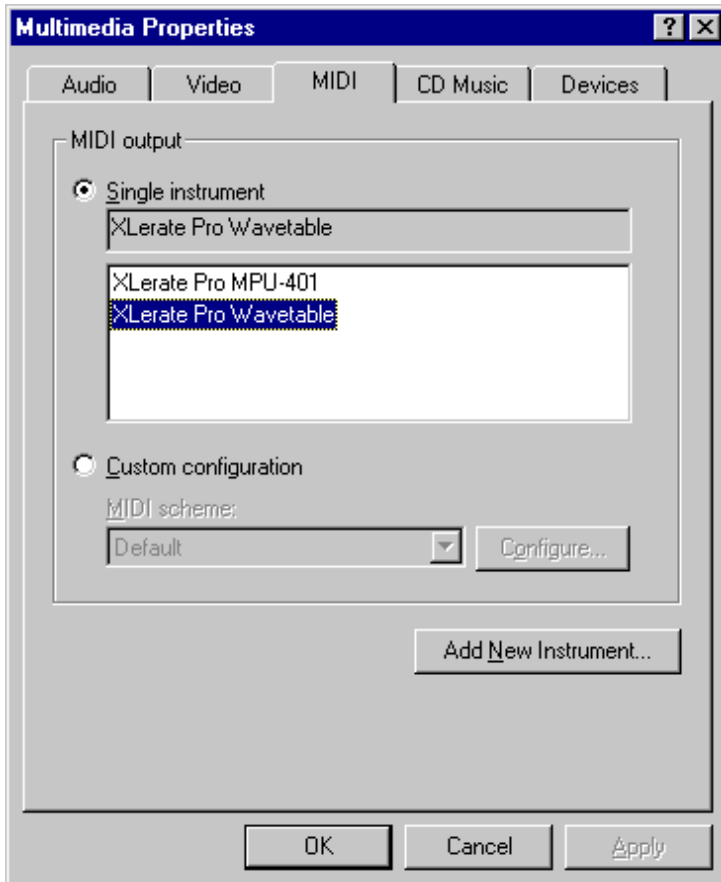

Next, check the MIDI settings. Open the control panel and double-click **Multimedia**. Go to the **MIDI** tab.

If you do not have an external wavetable or wavetable daughterboard, please ensure that the **XLerate Pro Wavetable MIDI** entry is active, not **XLerate Pro MPU-401 Interface**.

If you have an external wavetable or wavetable daughterboard installed, use this window to set the MIDI output to suit your requirements.

INSTALLATION OF THE BUNDLE SOFTWARE

The included bundle software can be installed either manually or automatically using the XLERate Pro Autostarter.

MANUALLY

WAVELAB LITE

Change to the folder <CD>:\Wavelab Lite and start **SETUP.EXE**. Follow the instructions of the installation program.

INTERNETPHONE 4.5

Change to the folder <CD>:\InternetPhone 4.5 and start **SETUP.EXE**. Follow the instructions of the installation program.

MIXMAN BASE EDITION

Change to the folder <CD>:\MixmanBE and start **SETUP.EXE**. Follow the instructions of the installation program.

WINJEY

Change to the folder <CD>:\WinJey and start **WINJ_101.EXE**. Follow the instructions of the installation program.

MICROSOFT INTERNET EXPLORER

Change to the folder <CD>:\HotStuff\Internet Explorer\English and start **IE5SETUP.EXE**. Follow the instructions of the installation program.

IBM VIAVOICE 98 30-DAY TEST VERSION

Change to the folder <CD>:\Hotstuff\ViaVoice98 and start **SETUP.EXE**. Follow the instructions of the installation program.

Important note: To achieve the highest possible speech recognition rate, use only high-quality headsets or microphones with IBM ViaVoice 98.

AUTOMATICALLY USING THE XLERATE PRO AUTOSTARTER

Using the XLerate Pro Autostarter simplifies the installation by eliminating the need to access the various installation folders manually.

If the AutoPlay function is enabled on your computer, simply insert the XLerate Pro CD in your CD-ROM drive and the Autostarter will be invoked. If the Autostarter does not come up automatically, double-click on the XLerate Pro CD icon in My Computer.

Next, use the Autostarter menu to install the bundle software, browse the contents of the CD, etc.

CONNECTING EXTERNAL PERIPHERY

The external devices you can connect to your XLERate include speakers or headphones, the audio output of your CD-ROM drive, a MIDI keyboard, a microphone and a joystick. Additional analog and digital audio devices (tuner, mixer, CD player, MiniDisc recorder, DAT recorder, etc.) may also be used.

CONNECTING SPEAKERS / HEADPHONES.

The **Line-Outs 1 and 2** can be used for all external devices such as headphones, active speakers or your stereo system. Line-Out 1 must be used when using 2 speakers or a head-phone. When using 4 speakers, connect the front speakers to Line-Out 1 and the rear pair to Line-Out 2.

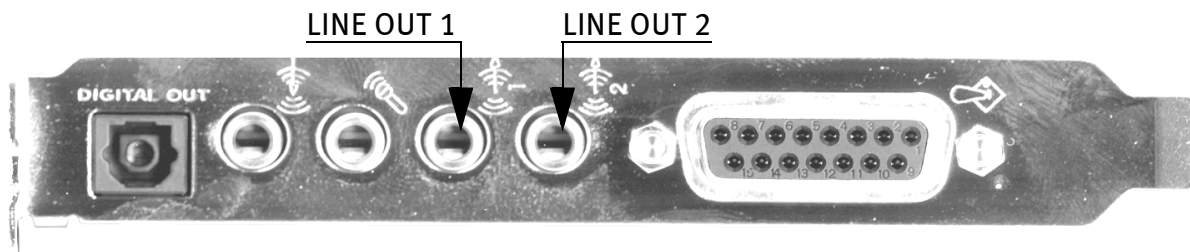

SETTING UP THE SPEAKERS FOR AN OPTIMAL A3D ACOUSTIC IMAGE

We recommend setting up the speakers as shown in the diagram to ensure optimal enjoyment of the A3D acoustic image.

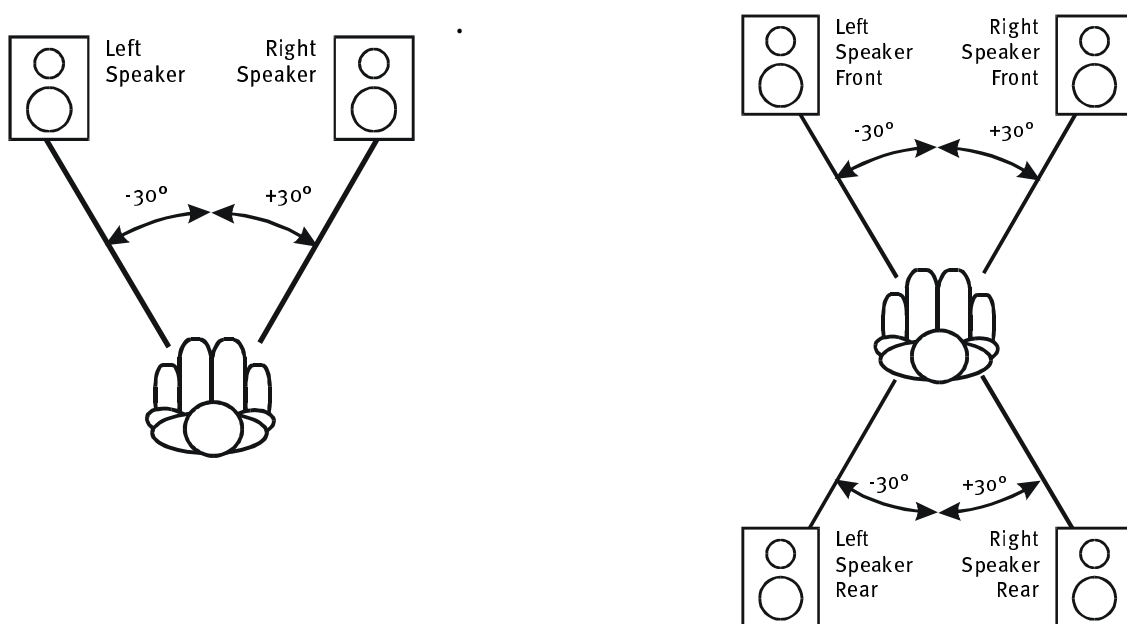

CONNECTING A MICROPHONE.

The input sensitivity should be adequate for most mainstream commercially available capacitor-type and dynamic microphones.

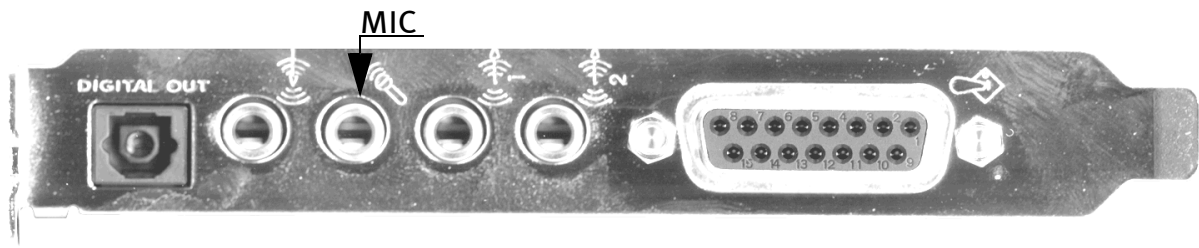

CONNECTING AN EXTERNAL AUDIO SOURCE.

Use the input labeled LINE IN for connecting external periphery such as a mixer, CD player, cassette recorder or similar. These external audio sources can be mixed with the internal audio sources using the mixer ([page 49](#)) or digitally recorded.

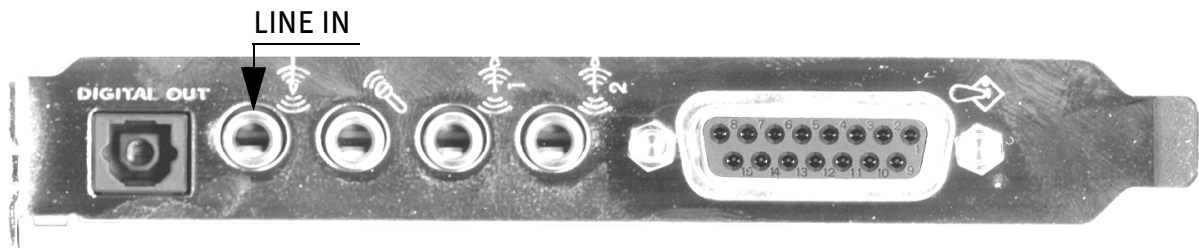

CONNECTING A DIGITAL AUDIO SOURCE.

The digital output is intended for external devices such as MiniDisc or DAT recorders. 32, 44.1 and 48 kHz are supported. Use a standard TOS-link cable for the connection.

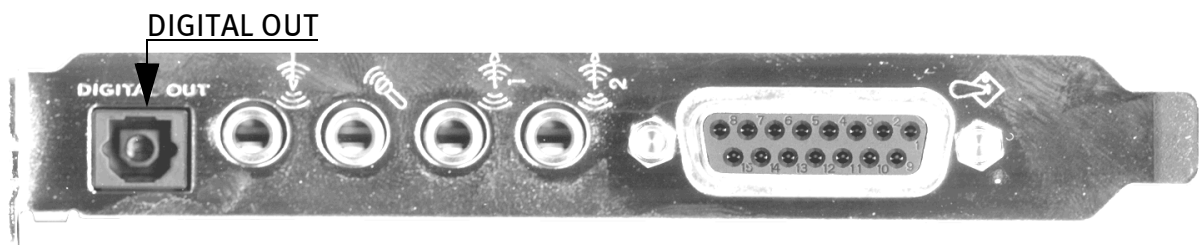

MIDI PORT

A special cable, which is optionally available as the TerraTec MIDI-KIT, is necessary to connect your sound card to a MIDI keyboard, an external synthesizer or expander. This cable is included with TerraTec keyboards. When connected to the game/MIDI port, it provides joystick, MIDI In and MIDI Out connections.

Important: Use only the MIDI cable provided by the sound-card OEM.

Connect the MIDI Out of your keyboard to the MIDI In of the MIDI-KIT. You can now record music using your keyboard and a sequencer program. If you would like to play back your MIDI files using external MIDI devices as well, connect the MIDI Out plug of the MIDI kit to the MIDI In socket of your expander, synthesizer or keyboard.

The MIDI/joystick is a 15-pin socket to which you can also connect a joystick.

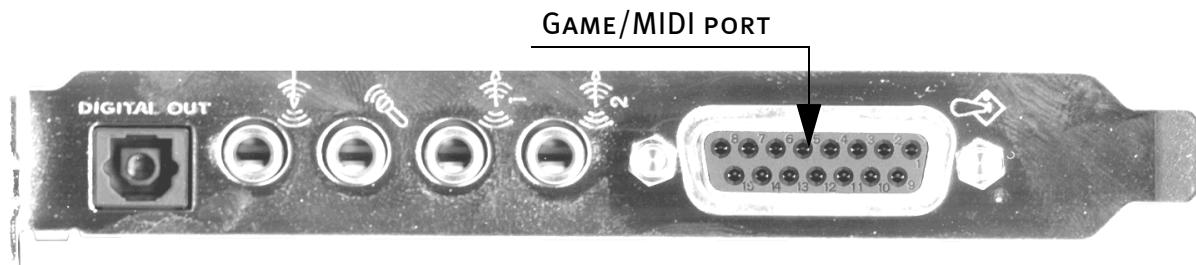

CONNECTING THE JOYSTICK

The 15-pin socket mentioned above can be used to connect one or two joysticks. The port can be enabled and disabled via the configuration. Bear in mind that you can have only one active joystick port in your PC configuration. If you want to use the port on your sound card you will have to deactivate any other joystick port in the system.

CD-ROM AUDIO CONNECTOR.

Connect the audio cable from the CD-ROM drive to the black MPC3 connector on the XLerate Pro card. The correct type of audio cable is generally included with the CD-ROM drive. For further information, please check the documentation of your CD-ROM drive.

TAD CONNECTOR

The TAD connector—a green MPC3 connector—is intended for audio connections to internal modem cards or similar devices. This permits audio signals from the modem to be played back using the sound card, as well as sending audio signals to the audio input of the modem, for example when recording answering-machine messages for a voice modem with a microphone connected to the sound card.

AUX CONNECTOR

The Aux connector—a white MPC3 connector—is a stereo line input that you can use as an audio connection for your CD-R recorder, the TerraTec TerraTV+ or TerraTVRadio+.

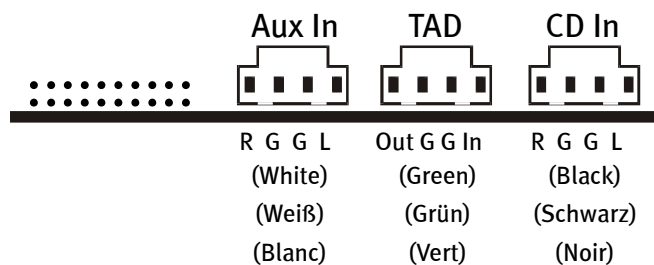

CONNECTING UPGRADE CARDS

CONNECTING A WAVETABLE MODULE

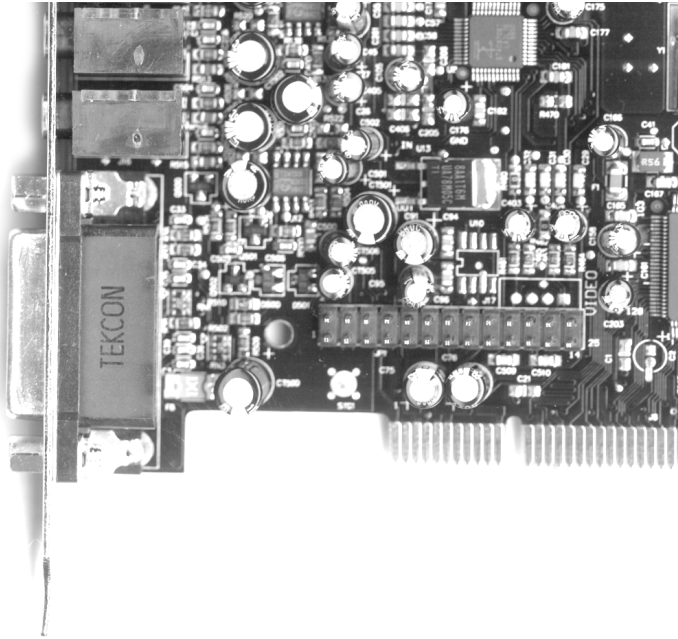

WaveBlaster pin-compatible wavetable modules can be connected to the XLerate Pro Wavetable Xtension. Take care to connect the wavetable module correctly, i.e. pin 1 on the XLerate Pro Wavetable Xtension to socket 1 of the wavetable module. Both connector rows must be correctly aligned to one another. Please also refer to the documentation supplied by the manufacturer of the wavetable module.

EXPANSION CONNECTOR

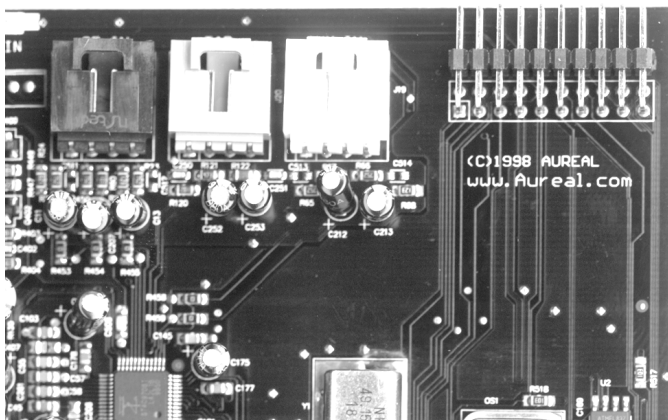

The expansion connector permits additional hardware to be added to enhance the functionality of the XLerate Pro. No additional hardware is currently available for the XLerate Pro, however.

This connector is NOT suitable for the ActiveRadio Receiversystem upgrade module. TerraTec shall assume no liability for hardware damage resulting from the improper use of the expansion connector!

THE XLERATE PRO CONTROLPANEL.

The ControlPanel puts the XLerate Pro's full functionality at your fingertips, from the speaker configuration, to the graphic equalizer, to loading alternative sample sets. The following chapter contains more information on these topics.

The XLerate Control Panel is also available under Windows NT 4.0, but is limited to the Control Panel and MIDI tabs. The other tabs—A3D Settings, A3D Demos and Digital Output—are not available, as these function are currently only supported by Windows 95/98 drivers.

CONFIGURING THE XLERATE CONTROL PANEL

The XLerate Pro ControlPanel icon is automatically added to the Windows Control Panel and the taskbar after the drivers have been installed.

If the XLerate Pro ControlPanel icon does not appear in the taskbar, please open the Windows Control Panel and start it from there. Uncheck the **Show tray control on the taskbar** option and check it again to display the icon on the taskbar.

STARTING AND EXITING THE XLERATE PRO CONTROL PANEL

The XLerate Pro Control Panel can be launched from either the Control Panel or the taskbar.

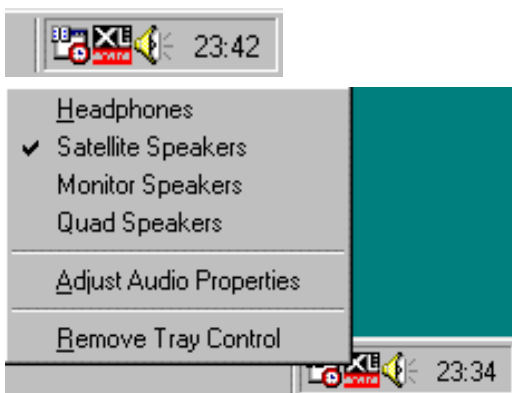

To open the XLerate Pro Tray Control menu, right-click on XLerate Pro icon in the taskbar tray.

Your settings can be adjusted very quickly using the opened menu.

SELECTING THE SOUND OUTPUT: (ONLY AVAIL-

ABLE UNDER WINDOWS 95/98)

- Headphones
- Satellite speakers
- Monitor speakers
- Quad speakers

The speaker configuration can be set up here to ensure that the algorithms designed specifically for a given type of output are used to ensure the best possible audio playback in applications that support A3D™ or DirectSound™3D.

SETTING THE AUDIO PROPERTIES

The XLerate Pro Control Panel can be launched from here as well.

REMOVING THE TRAY CONTROL

Removes the Tray Control icon from the taskbar. If you would like the XLerate Pro icon to reappear in the taskbar tray, open the Windows Control Panel, start the XLerate Pro ControlPanel and put a check mark next to **Show tray control on the taskbar**.



If the XLerate Pro icon does not appear in the taskbar, start the XLerate Control Panel from the Windows Control Panel and activate the **Show tray control on the taskbar** option.

CONTROL PANEL TABS



The Control Panel tabs can be used to launch a variety of multimedia applications such as the Volume Control, the Media Player, or the XLerate Pro 10-band graphic equalizer. The Multimedia and Game Controllers Control Panels can also be launched to configure various properties of the sound card.

The display of the SoundSystem XLerate Pro Control Panel in the taskbar can also be toggled here.

THE GRAPHIC EQUALIZER

The equalizer permits the individual adjustment of the relative levels of a variety of frequency bands. The equalization can be applied to the left and right channels together, or separately.

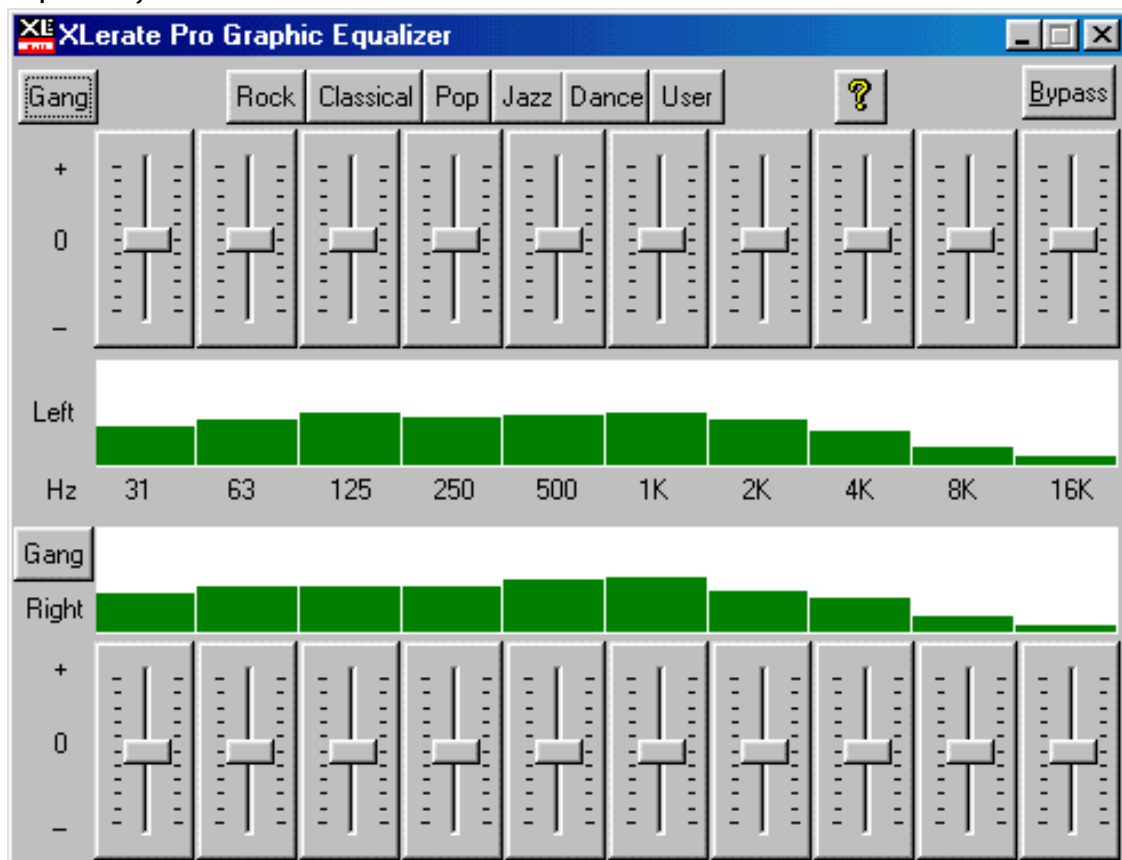

Together: Click **Together** to adjust the left and right channels as one.

Separate: Click **Separate** to adjust the left and right channels independently.

Equalizer presets are available for a variety of musical directions, or click **User** to adjust and save your own personal settings. These settings will be restored the next time you click on **User**.

Bypass: Click **Bypass** to disable the equalizer.

The final equalizer settings are retained after the application itself is closed; you can thus set the equalizer for a specific game, close the application and start the game.

MIDI TAB

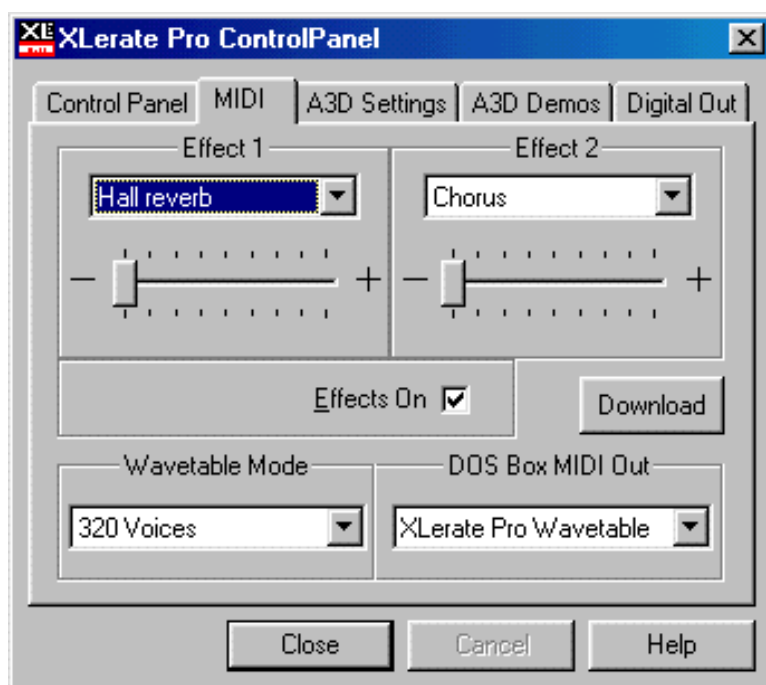

Effect 1 and Effect 2: Here you can apply 2 of 8 effects on a MIDI piece and set the intensity of the effect with the slider below the name of the effect. An effect can only be selected once; i.e., if Chorus has been selected as Effect 1, it can no longer be selected for Effect 2. In addition, all effects can be disabled. The effects are only available for MIDI pieces played back using the XLerate

ate Pro wavetable.

Loading: Opens a dialog in which you can load alternative sample sets into the memory. The sample set must comply with the DLS 1.0 specification and should be no larger than half of the total system memory. The new instruments are available immediately after being loaded into memory; rebooting is not necessary. If you would like to return to the default sample set, go to the `system` subfolder of your Windows folder under Windows 95/98, or to the `system32` subfolder of your Winnt folder under Window NT 4.0, and load the file `au30gm.ar1`.

Wavetable mode . Specify the maximum number of available voices here. The first 64 voices are handled completely by the XLerate Pro chip; the remaining 256 voices are software-based.

DOS box MIDI output: Here you can specify whether the XLerate Pro wavetable or a device connected to the MPU-401 interface—such as a wavetable daughterboard—will receive and play the MIDI data from a Windows 95/98 DOS box. If you do not have an external MIDI device, select **XLerate Pro Wavetable**. This selector box is only available under Windows 95/98.

A3D SETTINGS TAB

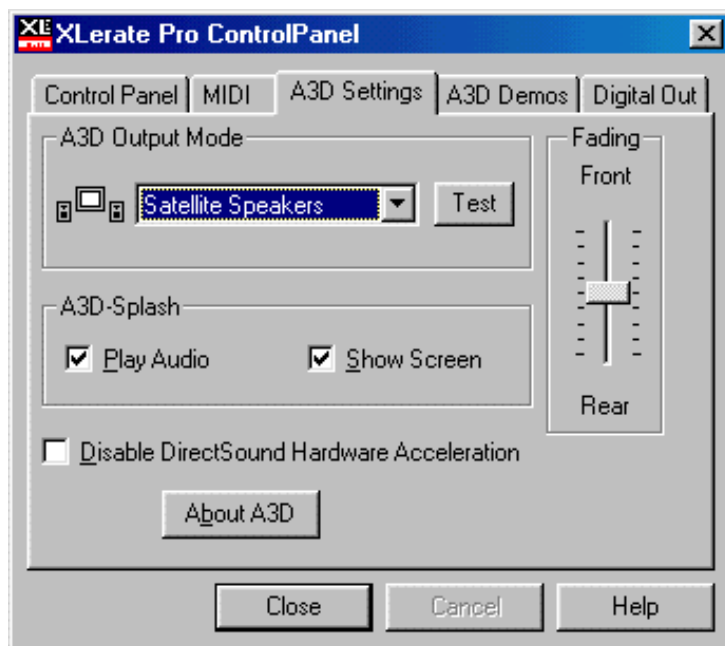

The parameters specifically relevant to the playback of A3D™ can be set up here.

A3D OUTPUT MODE

Headphones . Select this mode if you will be using headphones.

Satellite Speakers: If your speakers are widely spaced.

Monitor Speakers: If your speakers are located close to one another.

Quad Speakers: For four speakers, i.e. two pairs of speakers.

Fading: Use the Fading slider to balance the levels of the front and rear speaker pairs when in Quad Mode.

A3D SPLASH

Depending on whether or not you have marked the **Play Audio** or **Show Screen** checkboxes, applications that support A3D will play A3D sound and display the A3D logo, as well as indicating the selected playback mode (headphones, quad speakers...)

DISABLE DIRECTSOUND HARDWARE ACCELERATION

This checkbox can be used to disable the XLerate Pro's DirectSound hardware acceleration. Certain games do not check the actual number of available DirectSound hardware buffers. This can lead to program errors, making it advisable to disable DirectSound hardware acceleration in such cases.

A3D DEMOS TAB

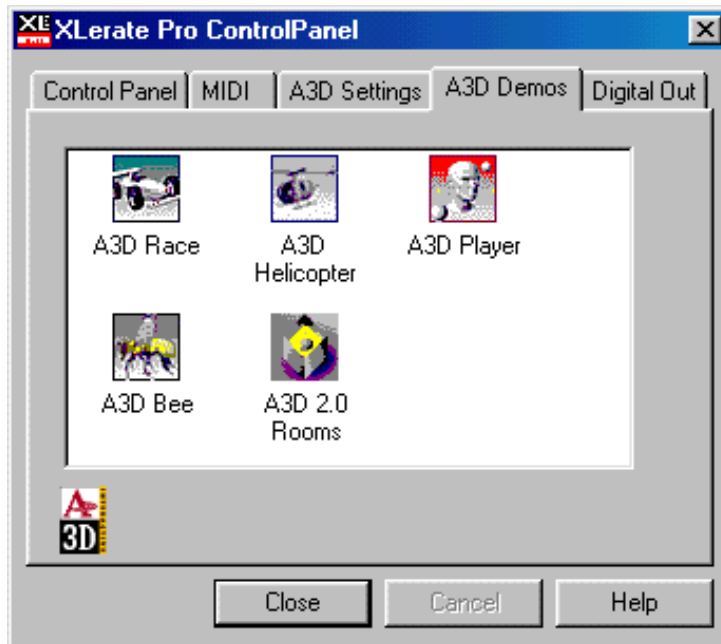

Here you can start one of five A3D demos for an impressive introduction to the capabilities of A3D. An additional four demos can be found in the A3D folder of the *XLerate Pro Software & Driver CD*, in the wavetracing subfolder, and can be installed using the setup program. These provide a superb demonstration of the A3D™2.0 wavetracing technology.

DIGITAL OUT TAB

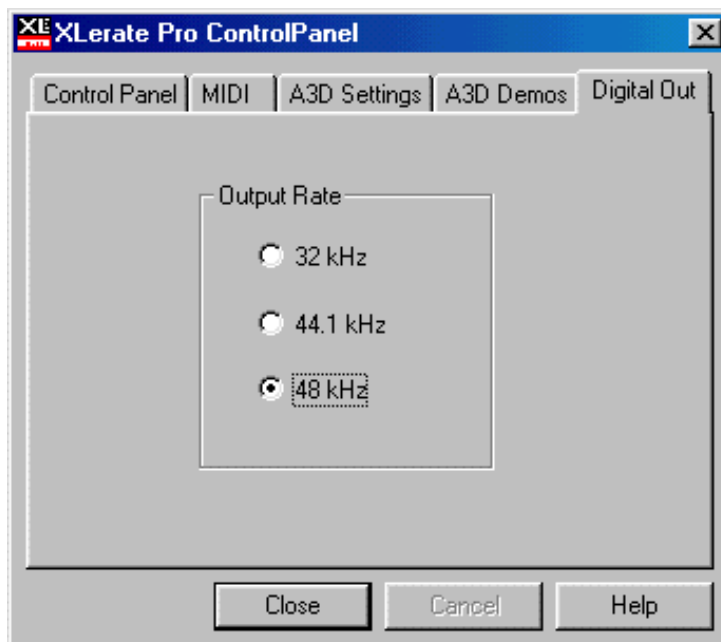

Specify the output frequency of the XLerate Pro's optical digital output on this tab. Changes to the output frequency are effective immediately and do not require the XLerate Pro ControlPanel to be closed, or Windows 95/98 to be restarted.

THE MIXER



The recording and playback levels can be adjusted using the standard Windows 95/98 mixer. The mixer can be launched using the speaker icon in the Windows 95/98 taskbar. If the symbol is not present, the mixer can also be launched via the ***XLerate Pro ControlPanel***. To display the speaker icon on the taskbar, go to the ***XLerate Pro Control Panel Multimedia*** section and select the ***Audio*** tab. A checkbox which toggles the display of the speaker icon can be found there below the audio playback settings.

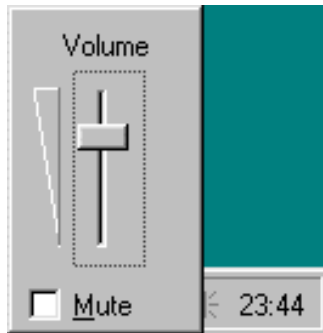

The volume control in the taskbar controls the master volume of Windows 95/98, of DOS box audio output, as well as that of real-mode DOS. To adjust the volume of DOS applications, start Windows 95/98 and use the Windows volume control.

If this results in individual audio sources being too loud, they can be adjusted separately using the mixer.

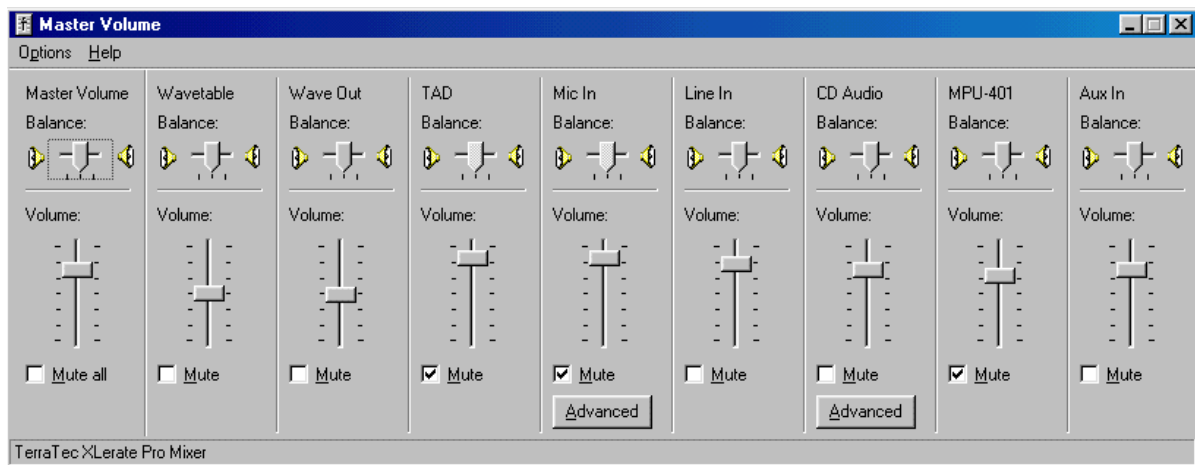

Note: the Windows mixer can also display audio sliders which are not supported by the hardware.

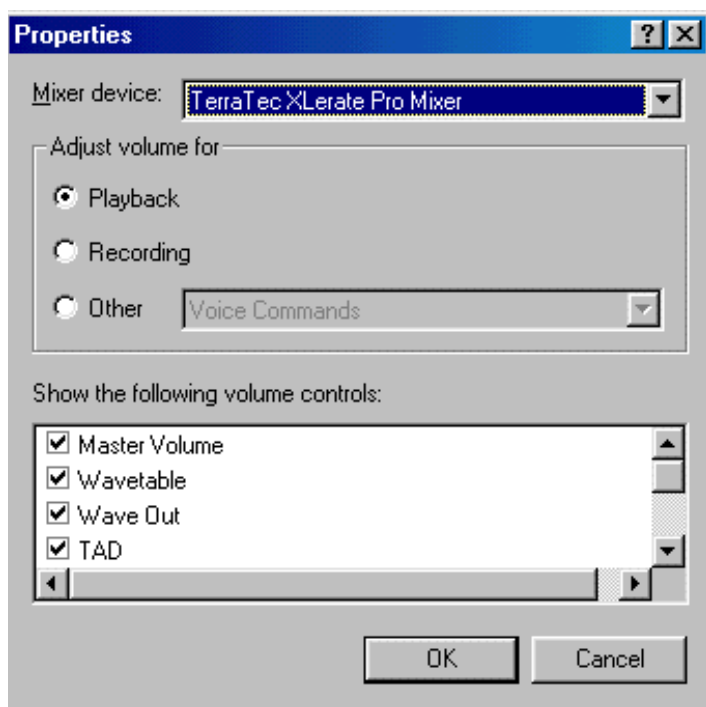

The display of the individual sliders can be selected under **Options** → **Properties**.

The settings for the recording mixer can be adjusted at the same time. The recording sensitivity of voice control software can be adjusted here independently of the recording and playback sliders, provided that the software supports this option.

To start the recording mixer, select **Recording** and click **OK**.

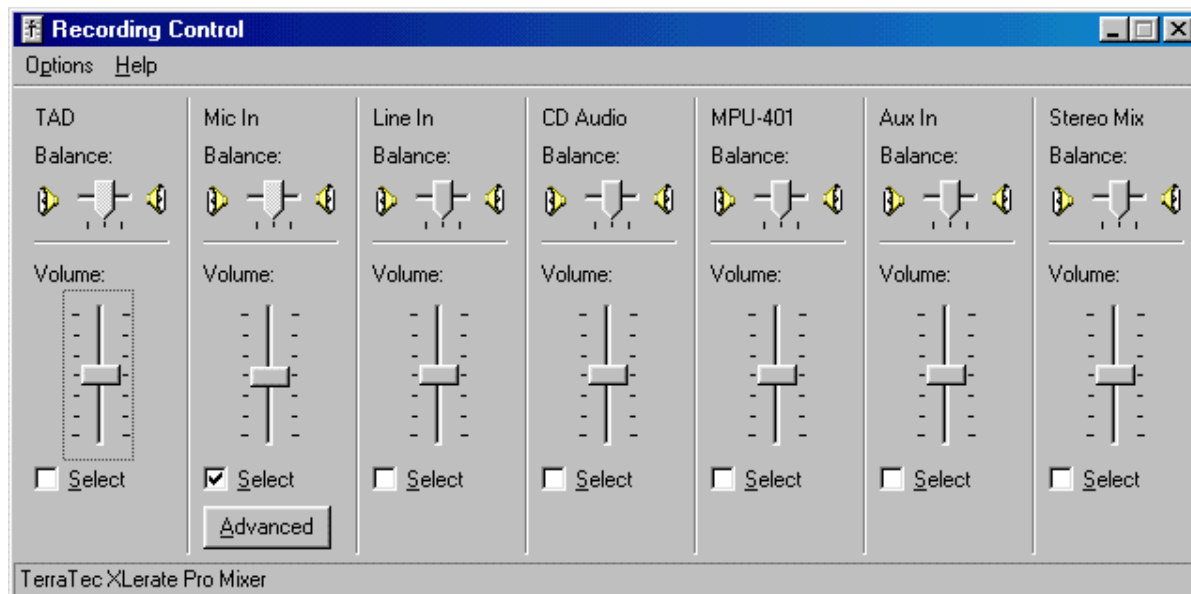

To record a specific audio source, select it here and adjust the slider accordingly.

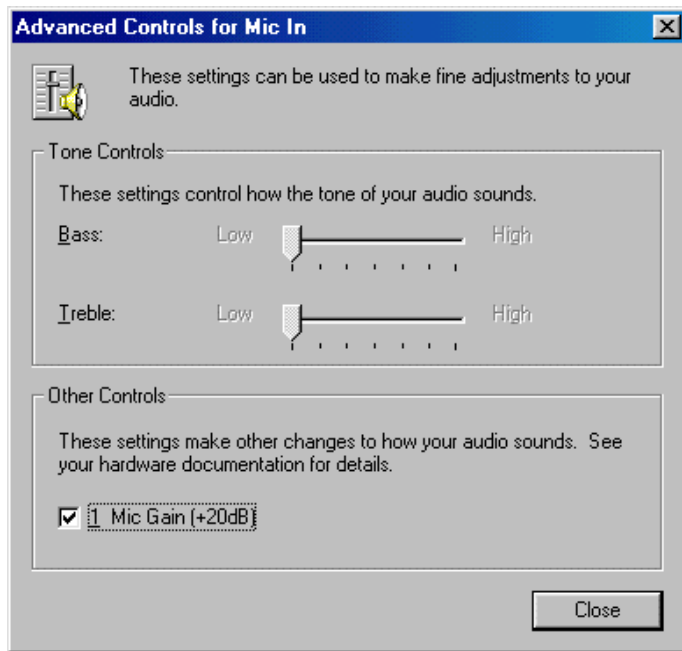

Both the recording and playback mixers offer the menu item **Advanced Controls** under **Options**. If this item is checked, both mixers display an **Advanced** button. This provides a wider range of adjustment options. Windows 95 also automatically displays sliders for the **Tone Controls**, even if these are not supported by the driver software.

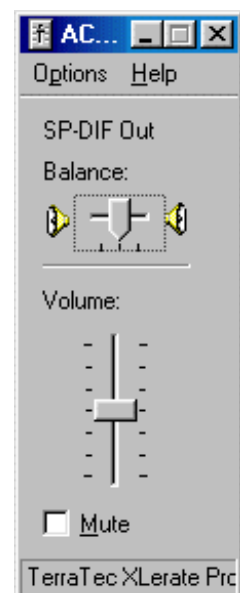
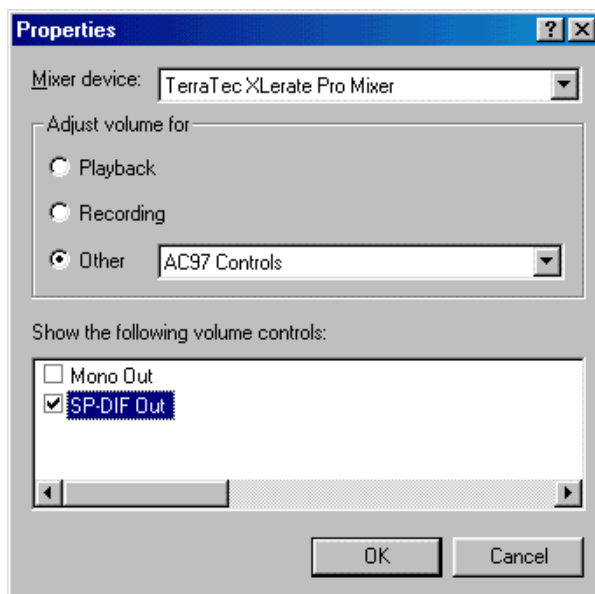

To adjust the level of the digital output, click on **Options** → **Properties** in the Mixer and select **Other** → **AC97 Controls**. You will then be able to set the SP-DIF Out level.

LEGACY AUDIO CONFIGURATION

Modifying the **Legacy Audio** settings will not be necessary in most cases. Should the need arise however, if a game requires settings other than the default, or you have an additional sound card in your system, refer to this section for details.

The free resources of your PC are checked and recorded in a list of possible basic configurations during the installation of the XRate Pro. The most suitable configuration is at the head of the list.

Configuration	AdLib I/O Port	SoundBlaster Pro I/O Port	SoundBlaster Pro Interrupt	SoundBlaster Pro DMA Channel
Basic Conf. 0	388h	220h	5 or 7	1 and 3
Basic Conf. 1	388h	240h	5 or 7	1 and 3
Basic Conf. 2	388h	220h or 240h	5, 7, 9 or 10	1 and 3
Basic Conf. 3	388h	220h or 240h	5 or 7	1
Basic Conf. 4	388h	220h or 240h	5 or 7	3
Basic Conf. 5	388h	220h or 240h	5, 7, 9 or 10	0, 1, or 3
Basic Conf. 6	388h	220h, 240h, 260h or 280h	5, 7, 9 or 10	0, 1, or 3

The Windows 95/98 **Device Manager** may indicate hardware conflicts if addresses, interrupts and DMA channels used by the SoundBlaster Pro emulation are already in use by another card. Use the following procedure to correct these conflicts manually.

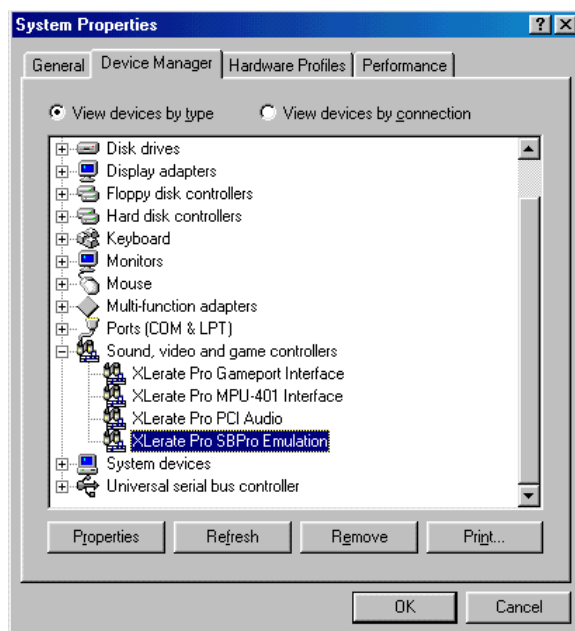

Open the Windows 95/98 **Device Manager**. Click on the plus sign in front of **Sound, video and game controllers** to access the properties of the SoundBlaster emulation.

Highlight the entry **TerraTec XRate Pro SBPro Emulation**.

Click on **Properties** and on the **Resources** tab in the following window.

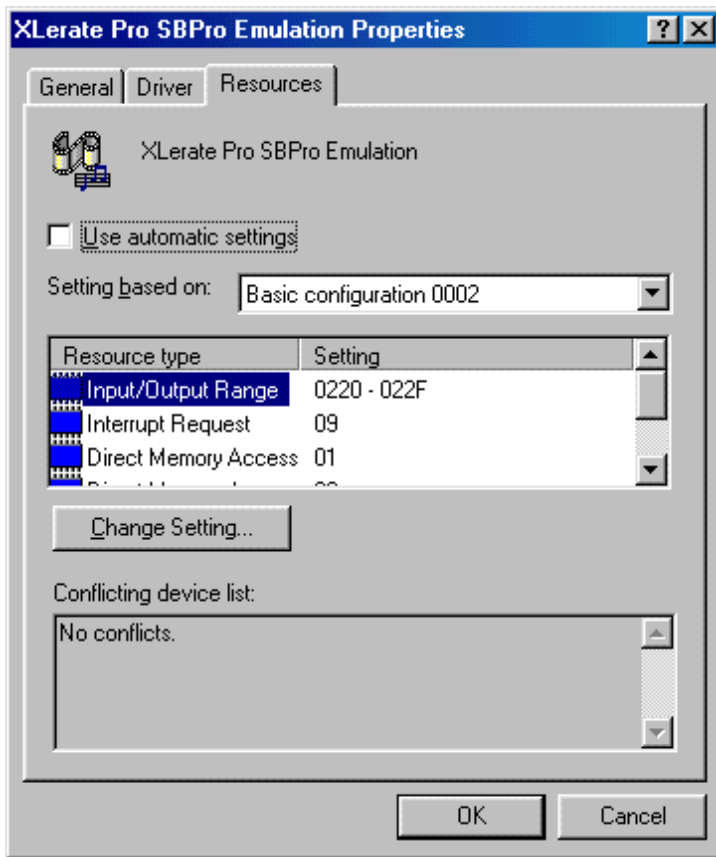

Remove the check mark next to **Use automatic settings** to permit the settings to be changed manually. Next, select one of the basic configurations in order to manually change the resources. Next, click **Change settings...** Please note that not every basic configuration permits the modification of settings. Try a few different basic configurations until you find one that permits resources to be changed manually.

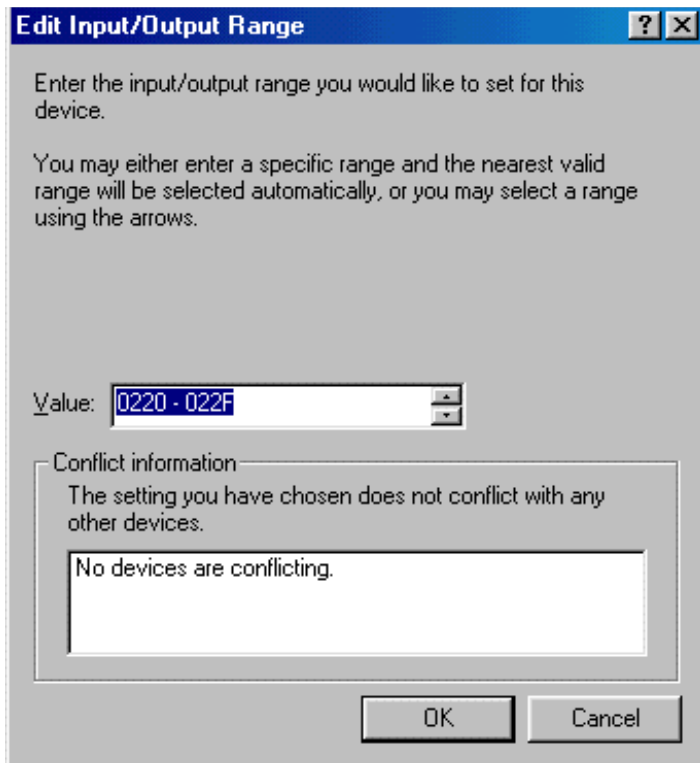

You can then assign different resources once you have found such a basic configuration.

Please bear in mind that manual configuration may prevent some applications which require default settings from accessing resources. Please refer to the documentation of your application if necessary to determine which resources the program requires.

Some applications require the so-called BLASTER environment variable. The appropriate modifications were made to your AUTOEXEC.BAT and DOSSTART.BAT files automatically while installing the XLerate Pro drivers.

Your AUTOEXEC.BAT and DOSSTART.BAT should then look something like this:

```
PATH=C:\WINDOWS
.
.
.
LH C:\WINDOWS\AU30DOS.COM
SET BLASTER=A220 I5 D3 T4
```

The last two lines were added by the XLerate Pro installation routine.

The first line installs the XLerate Pro DOS driver, AU30DOS.COM, which can be found in the Windows folder.

If your computer does not display the Windows 95/98 logo while booting, you should see the following entry.

```
VORTEX DOS AUDIO DRIVER (2.000b). Copyright (C) 1997,98 Aural
Semiconductor
PCI AUDIO PRO enabled at Ports 220-22Fh, Interrupt 5, DMA 3,
Joystick 201h.
```

In the event that your computer does display the Windows 95/98 logo, use the **Escape** key to switch to the appropriate view to see which drivers and programs are being loaded.

If Windows 95/98 is being started instead of DOS, the driver is automatically removed from the computer's memory to ensure optimum Windows 95/98 performance, as Windows 95/98 does not use the driver.

The second line added to the AUTOEXEC.BAT and DOSSTART.BAT files sets the BLASTER environment variable with the suitable values for the resources.

Detailed information on the significance of the individual entries can be found in the Appendix under **Frequently Asked Questions**(page 61) .

CONFIGURING THE MIDI PORT ADDRESS MANUALLY

A number of games have the option of playing back music via MIDI. You can select the integrated wavetable for playback in Win 95/98 DOS boxes. This has already been explained in the chapter *The XLerate Pro ControlPanel* (page 41) in the *MIDI Tab* (page 46) section. It's possible to set the MIDI port as shown to ensure that the correct port is addressed by the game.

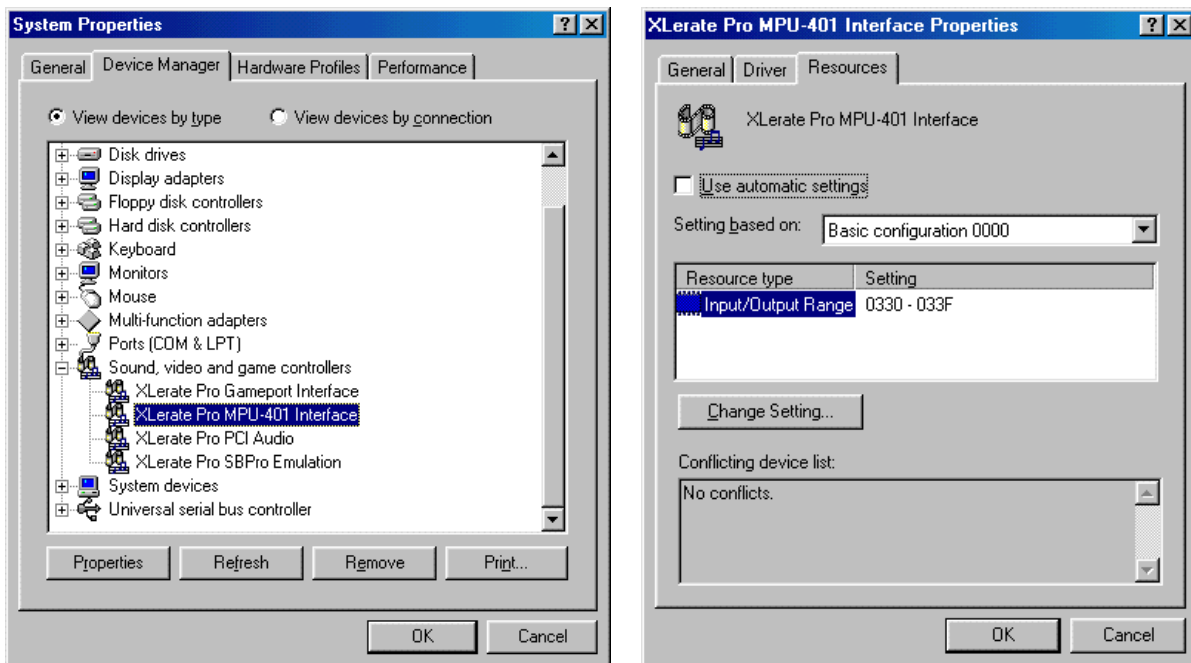

The resources for the SoundBlaster emulation can be changed manually in a manner similar to the procedure described above.

MANUAL CONFIGURATION OF THE GAMEPORT ADDRESS

As DirectX is installed together with the XLerate Pro drivers—assuming it is not pre-installed—Windows then expands the *Joystick* driver to a *Game Controller* driver. Routines were added to accelerate the polling of the joystick, for example.

You can also modify these settings with the procedure described above.

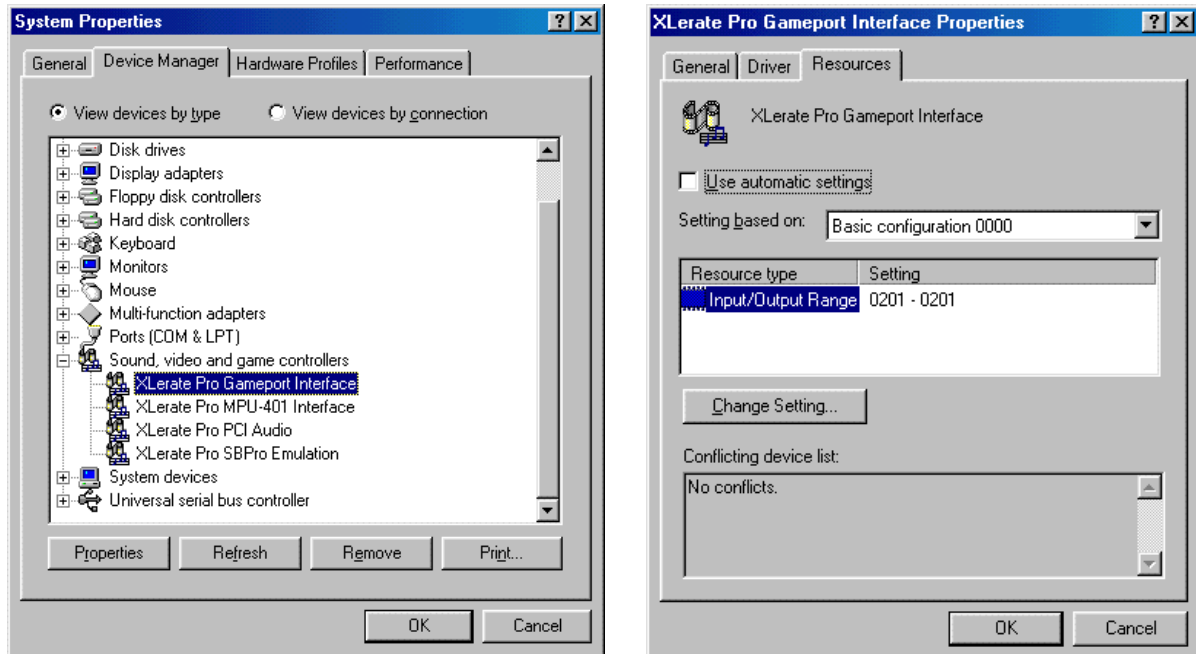

Games which run in a Windows 95/98 DOS box use the *gameport* address specified in the Device Manager. Games which run under real-mode DOS are not affected by this setting and continue to use the default gameport address (201h).

Two different gameport drivers are available for the XLerate Pro.

The default Windows 95/98 gameport driver and the *XLerate Pro Gameport Interface*.

Open the *XLerate Pro ControlPanel* and start the *Game Controller*.



Click on **Add** to install joysticks and other game controllers. Please note that joysticks and game controllers are available which require a separate driver installation, such as the Microsoft **Force Feedback Pro**.

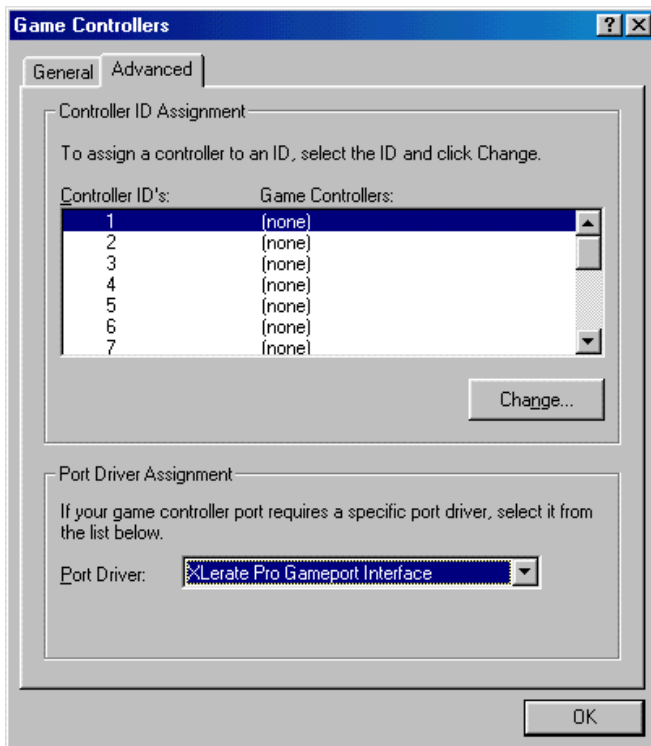

Switch to the **Advanced** tab to select a driver for the gameport interface.

Windows uses the **standard gameport interface** by default. The regular polling of the joystick is performed by the CPU when using this driver, which of course reduces the system performance somewhat.

On the other hand, the **XLerate Pro Gameport Driver** runs DirectX DirectInput routines on the XLerate Pro hardware. That reduce the CPU load!

APPENDIX

WAVETABLE INSTRUMENT TABLE

Program	Instrument Name	Voices	Program	Instrument Name	Voices	Program	Instrument Name	Voices
0	(Grand) Piano 1	1	43	Contrabass	1	86	Lead 7 (fifths)	2
1	(Bright) Piano 2	1	44	Tremolo Strings	1	87	Lead 8 (bass+lead)	2
2	(El. Grd) Piano 3	1	45	Pizzicato Strings	1	88	Pad 1 (new age)	3
3	Honky-tonk Piano	2	46	Orchestral Harp	2	89	Pad 2 (warm)	1
4	El. Piano 1	1	47	Timpani	1	90	Pad 3 (polysynth)	2
5	El. Piano 2	1	48	String Ensemble 1	1	91	Pad 4 (choir)	2
6	Harpsichord	1	49	String Ensemble 2	1	92	Pad 5 (bowed)	2
7	Clavi	2	50	Synth Strings 1	2	93	Pad 6 (metallic)	2
8	Celesta	1	51	Synth Strings 2	1	94	Pad 7 (halo)	2
9	Glockenspiel	1	52	Choir Aahs	1	95	Pad 8 (sweep)	2
10	Music Box	2	53	Voice Oohs	2	96	FX 1 (rain)	2
11	Vibraphone	1	54	Synth Voice	1	97	FX 2 (soundtrack)	2
12	Marimba	1	55	Orchestra Hit	1	98	FX 3 (crystal)	2
13	Xylophone	1	56	Trumpet	1	99	FX4 (atmosphere)	2
14	Tubular Bells	1	57	Trombone	1	100	FX 5 (brightness)	2
15	Dulcimer (Santur)	1	58	Tuba	1	101	FX 6 (goblins)	2
16	Drawbar Organ	1	59	Muted Trumpet	1	102	FX 7 (echoes)	1
17	Percussive Organ	2	60	French Horn	2	103	FX 8 (sci-fi)	2
18	Rock Organ	1	61	Brass Section	1	104	Sitar	1
19	Church Organ	1	62	Synth Brass 1	1	105	Banjo	1
20	Reed Organ	1	63	Synth Brass 2	1	106	Shamisen	1
21	Accordion (french)	2	64	Soprano Sax	2	107	Koto	1
22	Harmonica	1	65	Alto Sax	1	108	Kalimba	1
23	Tango Accordion	2	66	Tenor Sax	2	109	Bag pipe	1
24	Ac. Guitar (Nylon)	1	67	Baritone Sax	1	110	Fiddle	1
25	Ac. Guitar (Steel)	1	68	Oboe	1	111	Shanai	1
26	El. Guitar (jazz)	2	69	English Horn	2	112	Tinkle Bell	2
27	El. Guitar (clean)	1	70	Bassoon	1	113	Agogo	1
28	El. Guitar (muted)	1	71	Clarinet	1	114	Steel Drums	1
29	Overdriven Guitar	1	72	Piccolo	1	115	Woodblock	1
30	Distortion Guitar	1	73	Flute	1	116	Taiko Drum	1
31	Guitar harmonics	1	74	Recorder	1	117	Melodic Tom	1
32	Acoustic Bass	2	75	Pan Flute	2	118	Synth Drum	1
33	Elec. Bass (finger)	2	76	Blown Bottle	2	119	Reverse Cymbal	1
34	Elec. Bass (pick)	2	77	Shakuhachi	2	120	GuitarFretNoise	1
35	Fretless Bass	1	78	Whistle	1	121	BreathNoise	2
36	Slap Bass 1	2	79	Ocarina	2	122	Seashore	2
37	Slap Bass 2	1	80	Lead 1 (square)	1	123	Bird Tweet	1
38	Synth Bass 1	1	81	Lead 2 (sawtooth)	1	124	TelRing	1
39	Synth Bass 2	3	82	Lead 3 (calliope)	3	125	Helicopter	1
40	Violin	1	83	Lead 4 (chiff)	1	126	Applause	2
41	Viola	1	84	Lead 5 (charang)	1	127	Gunshot	1
42	Cello	1	85	Lead 6 (voice)	1			

WAVETABLE PERCUSSION TABLE

Note	Key	Instrument	Note	Key	Instrument	Note	Key	Instrument
C2	36	Rock Bass Drum	F#3	54	Tambourine	C5	72	Long Whistle [EXC2]
C#2	37	Side Stick	G3	55	Splash Cymbal	C#5	73	Short Guiro [EXC3]
D2	38	Snare Drum 1	G#3	56	Cowbell	D5	74	Long Guiro [EXC3]
D#2	39	Hand Clap	A3	57	Crash Cymbal 2	D#5	75	Claves
E2	40	Snare Drum 2	A#3	58	Vibraslap	E5	76	Hi Wood Block
F2	41	Low Floor Tom Tom	B3	59	Ride Cymbal 2	F5	77	Low Wood Block
F#2	42	Closed HiHat [EXC1]	C4	60	Hi Bongo	F#5	78	Mute Cuica [EXC4]
G2	43	High Floor Tom	C#4	61	Low Bongo	G5	79	Open Cuica [EXC4]
G#2	44	Pedal HiHat [EXC1]	D4	62	Mute Hi Conga	G#5	80	Mute 3angle [EXC5]
A2	45	Low Tom	D#4	63	Open Hi Conga	A5	81	Open 3angle[EXC5]
A#2	46	Open HiHat [EXC1]	E4	64	Low Conga	A#5	82	Shaker
B2	47	Low-Mid Tom	F4	65	High Timbale	B5	83	Jingle Bell
C3	48	Hi Mid Tom	F#4	66	Low Timbale	C6	84	BellTree
C#3	49	Crash Cymbal 1	G4	67	High Agogo	C#6	85	Castanets
D3	50	High Tom	G#4	68	Low Agogo	D6	86	Mute Surdo [EXC6]
D#3	51	Ride Cymbal 1	A4	69	Cabasa	D#6	87	Open Surdo [EXC6]
E3	52	Chinese Cymbal	A#4	70	Maracas	E6	88	-
F3	53	Ride Bll	B4	71	Short Whistle[EXC2]	F#3		

MIDI IMPLEMENTATION CHART

Message Type	Function	Status [b] (D7-Do)	Data (D7-Do) (D7-Do)	Description	RX	TX	
Channel Messages	Note Off	1000cccc	0kkkkkkk 0vvvvvvv	(kkkkkkk) = key (note) number. (vvvvvvv) = velocity.	O	X	
	Note On	1001cccc	0kkkkkkk 0vvvvvvv	(kkkkkkk) = key (note) number. (vvvvvvv) = velocity.	O		
	Control Change	1011cccc	0nnnnnnn 0vvvvvvv n = 1 n = 5 n = 7 n = 10 n = 11 n = 64 n = 91 n = 93 n = other	(nnnnnnn) = controller number. (vvvvvvv) = new value. Mod wheel. Data entry. Volume. Pan. Expression. Sustain. Reverb send. Chorus send. Other.		O O O O O O O O X	
	Mode Change	1011cccc	0nnnnnnn 0vvvvvvv n = 122, v = 0/ 127 n = 123, v = 0 n = 124, v = 0 n = 125, v = 0 n = 126, v = cccc n = 127, v = 0	(nnnnnnn) = controller number. (vvvvvvv) = new value. Local control off/on. All notes off. Omni mode on. [c] Omni mode off. [c] Mono mode on. [c] Poly mode on. [c]		X O X X X X	
	Program Change	1100cccc	0pppppppp	(pppppppp) = new program number.	O		
	Pitch Bend Change	1110cccc	0mmmmmmm 0nnnnnnn	(mmmmmmm) = LSBs. (nnnnnnn) = 7 MSBs. 200H = Center.	O		
	Pitch Bend Sensitivity	1011cccc	01000000 00000000 01000001 00000000 vvvvvvvv	(vvvvvvvv) = pitch bend sensitivity in 0-24 semitone range. default setting: 2 semitones.	X		
	Channel Aftertouch	1101cccc	0vvvvvvv	-	O		
	Polyphonic Aftertouch	1010cccc	0kkkkkkk 0vvvvvvv	(kkkkkkk) = key (note) number. (vvvvvvv) = pressure value.		X	
	System Messages	System Exclusive.	11110000	-	The XLERate Pro does not support any system exclusive messages. Wavetable support does not require support for sequencer control messages.	X	
End of Exclusive		11110111		X			
Song Pos.Ptr.		11110010	01111111 0mmmmmmm	X			
Song Select		11110011	0sssssss	X			
Tune Request		11110110	-	X			
Timing Clock		11111000	-	X			
Start		11111010	-	X			
Continue		11111011	-	X			
Stop		11111100	-	X			
Active Sense		11111110	-	-		X	
Reset		11111111	-	-		X	

- O = recognized, X = not transmitted/not recognized.
- cccc = MIDI channel 1~16.
- Causes all notes off.

SWITCHING OF THE MIDI INTERFACE

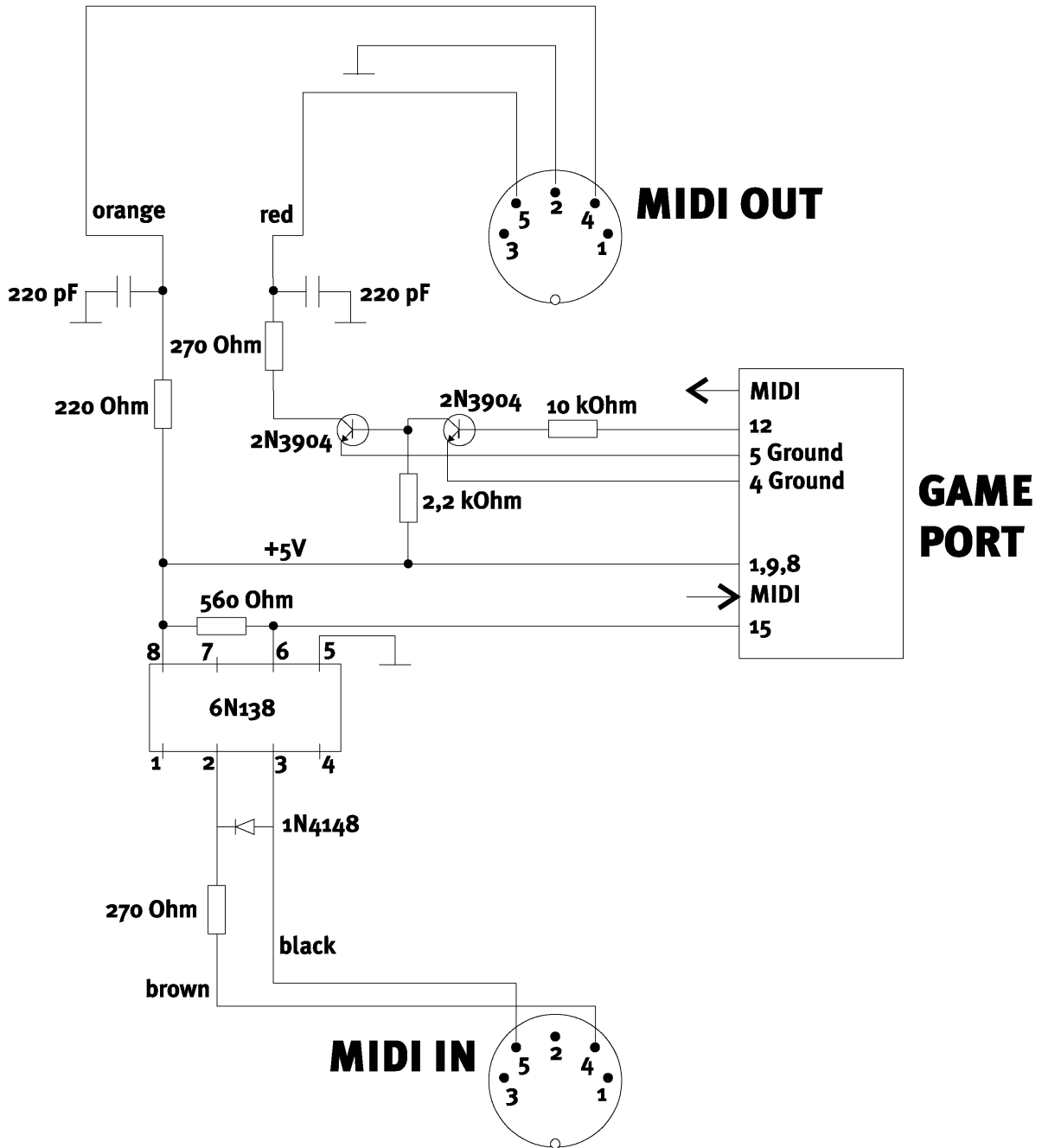

THE TERRATEC HOTLINE

If you still have problems or questions, please review all of the instructions in this handbook first. If you have questions related to MIDI or wavetable synthesis, please refer to the MIDI guide on the "XLerate Pro Software & Driver CD".

Please ensure that you are using the latest TerraTec XLerate Pro driver versions.

The latest versions are available from the following sources:

TerraTec ReActor BBS: +49 (0) 2157 8179-24 (analog)
+49 (0) 2157 8179-42 (ISDN)

TerraTec in the Internet: <http://www.terratec.net>

If you are certain that you can't solve your problem without assistance, please call our hotline.

If you live in:

Great Britain or Ireland, please dial (+44) 0 1600-772333 (Monday through Friday, 9:00 am - 5:00 pm - local time)

BeNeLux: please dial (+31) 043 3654758 (Monday through Friday, 15:00 - 18:00 local time)

USA: please dial (+1) 949 487-3774 (Monday through Friday, 10:00 am - 5:00 pm - Pacific time)

If you do NOT live in any of these countries, please dial +49 (0) 2157 817914.

Our friendly support team is available from Monday through Friday from 13:00 - 20:00 Central European Time. Please have the following information handy to ensure that your call is processed quickly:

- Your registration number
- This documentation and/or the Quick Reference
- A printout of your configuration files
- The manual of your motherboard
- A screenshot of your BIOS configuration.

If possible, call from within reach of your running computer. Please also note the name of the support team member who answers your call, as you will need it if you have to return a defective card.

Another source of help is our Internet support page:

<http://www.terratec.net/support.htm>

It is also useful to keep all of the information relevant to your computer handy when using this resource. Providing detailed information about your problem increases the chances of getting quick assistance.

Please do not send us calls for help by snail mail, fax or carrier pigeon. For organizational reasons we will not be able to respond.

TERRATEC SERVICE

TerraTec offers direct service, in other words if a malfunction occurs you can contact us instead of going through a retailer.

Your advantages are:

- **Shorter lines of communication:** Go straight to us instead of going through retail, wholesaler and distributor.
- **Better hands-on supervision:** The more intermediaries involved the bigger the chance of shipments going missing or suffering damage.
- **Faster handling:** Shipments are processed in the order in which they are received and not held back by a wholesaler or distributor who waits until a bulk shipment cuts costs.
- **Direct feedback:** If we have any queries we can contact you quickly and directly.

If you run into a problem you cannot solve please phone our hotline and note the name of the person who takes your call, because this will ensure that your card is not sent in vain.

This precaution will help save unnecessary cost. Experience shows that the chances of solving a problem on the phone are very high. The number of cards that are actually defective, on the other hand, is negligible by comparison.

Please observe the following points before returning a product.

1. Consult the appropriate part of the User Guide, just in case you missed something.
2. If you are experiencing a problem, always call the Hotline first. Many problems can be resolved by our competent support staff, thus saving time and postage.
3. Complete the front side of the service request form in a legible manner. A precise, detailed description of the fault will help us deal with the problem as quickly as possible. Returned products not accompanied with a description of the fault cannot be processed and will be returned at your expense.
4. A copy (not the original) of the sales receipt must be enclosed. If it is not included, we will assume that the warranty period has elapsed and will invoice you for the repair.

5. Please use sufficiently sturdy and well-padded packaging material. In our experience, the original packaging material is well-suited. Please bear the delicate nature of electronic components in mind.

6. Ensure that the package has adequate postage.

GENERAL TERMS OF SERVICE

1. GENERAL NOTES

Our general terms of service are deemed as accepted with the purchase and receipt of this product.

2. EVIDENCE OF WARRANTY

A copy of the sales receipt or bill of delivery must be provided as evidence of the validity of the warranty. All repairs will be invoiced if this is not observed.

3. DESCRIPTION OF THE FAULT

Returned products which are not accompanied with an adequate description of the fault ('defective' or 'repair required' will not be considered to be a sufficient description) will be returned subject to a service charge, as this complicates the repair process unnecessarily.

4. UNJUSTIFIED COMPLAINTS

In the event of unjustified complaints (no fault can be determined, apparent user error) we will return the product subject to a service charge.

5. PACKAGING

If possible, return the product in its original packaging material. The use of inadequate packaging material may void the warranty. Shipping damage resulting herefrom will void the warranty.

6. THIRD-PARTY PRODUCTS

Products not manufactured or distributed by TerraTec Electronic GmbH will be returned subject to a service charge.

7. REPAIRS SUBJECT TO INVOICE

Repairs made after the warranty period has elapsed will be invoiced.

8. SHIPPING COSTS

The costs for shipping and insurance of the product to be repaired by TerraTec Electronic GmbH shall be borne by the sender. In the event of warranty service, the costs for returning the product will be TerraTec Electronic GmbH. COD shipments will not be accepted for organizational reasons.

9. CLOSING PROVISIONS

TerraTec Electronic GmbH reserves the right to modify or supplement these general terms of service at any time.

The TerraTec Electronic GmbH general terms and conditions shall be considered accepted.