

VideoSystem



Digital Video Editing System

English Manual

---

CE - Statement

We:

TerraTec Electronic GmbH · Herrenpfad 38 · D-41334 Nettetal

hereby declare that the product:

VideoSystem Cameo 600 DV

to which this declaration refers complies with the following standards or standardizing documents:

1. EN 50081-1

2. EN 50082-1

The following are the stipulated operating and environmental conditions for the said compliance:

Residential, business and commercial environments and small-company environments.

This declaration is based on:

test report (s) of the EMC testing laboratory



TerraTec® ProMedia, SoundSystem Gold, SoundSystem Maestro, SoundSystem Base1, SoundSystem DMX, SoundSystemDMX XFire 1024, AudioSystem EWS®64, AudioSystem EWS88, AudioSystem EWX 24/96, XLerate, XLerate Pro, Base2PCI, TerraTec 128iPCI, TerraTec 512i digital, TerraTV+, TerraTV Radio+, TerraTValue, VideoSystem Cameo 600 DV, WaveSystem, TerraCAM USB, TerraCAM USB Pro, TerraCAM iLook, m3po, Phono PreAmp, MIDI Smart and MIDI Master Pro are trademarks registered by TerraTec® Electronic GmbH Nettetal.

In most cases, the designations used in this manual for software and hardware are also registered trademarks and are thus subject to the relevant regulations.

©TerraTec® Electronic GmbH, 1994-2001. All Rights Reserved (16.11.01).

All texts and regulations have been created with the utmost care. However TerraTec and its authors are not responsible in any way for possible incorrect specifications and their consequences. Technical specifications are subject to changes.

All texts of this documentation are copyright-protected. All rights reserved. No part of this documentation may be reproduced in any form as photocopy, microfilm or in any other way be transferred into a language or form, that may be used by a computer. All rights by reproduction in lecture, Radio or TV are reserved

---

## **Contents**

|  |    |
|--|----|
| Preface .....  | 4  |
| Installation .....   | 5  |
| The card's layout .....  | 5  |
| Installing the Cameo 600 DV – PCI card.....                        | 7  |
| Installation and connection of the Cameo Connect.....              | 9  |
| Connection of a DV – Camcorder .....                               | 11 |
| Connection of additional FireWire™-components .....                | 11 |
| Installation of drivers.....                                       | 12 |
| Installation using Windows 98 SE.....                              | 13 |
| Installation using Windows ME.....                                 | 16 |
| Installation using Windows 2000 .....                              | 18 |
| Software installation.....   | 19 |
| Installation of DirectX 8.0a and Digital Video Updates – CD 1..... | 19 |
| Installation of MediaStudio Pro 6.0 VE – CD 1.....                 | 19 |
| Installation of Adorage Magic - Volume 1 – CD 2.....               | 19 |
| Installation of Cool 3D 2.5 – CD 3 .....                           | 19 |
| Software overview .....  | 20 |
| MediaStudio Pro 6.0 VE.....  | 20 |
| Ulead DVD Plug-in .....  | 20 |
| Adorage Magic – Volume 1 .....                                     | 20 |
| Cool 3D 2.5.....   | 20 |
| First cuts.....  | 21 |
| DV recordings with Video Capture 6.0. ....                         | 21 |
| DV cuts with the Video Editor. ....                                | 23 |
| DV transmission to your camcorder. ....                            | 26 |
| Using the DVD Plug-in.....   | 27 |
| Appendix.....  | 28 |
| FAQ – Frequently Asked Questions and their answers .....           | 28 |
| The perfect computer.....  | 31 |
| You're not alone ... ..  | 32 |
| TerraTec service.....  | 34 |
| Glossary .....   | 36 |

---

## ***Preface***

Thank you for purchasing a product made by TerraTec. You have made a good choice, as the Cameo 600 DV is an impressive piece of "State of the art" technology. This product is one of the most efficient computer devices for video applications. We are convinced, that the Cameo 600 DV will serve you well and you will have a lot of fun, whenever you are using it.

---

## ***Installation***

### ***The card's layout***

#### **The external IEEE-1394-connectors**



These connectors allow you to connect the Cameo 600 DV to the rest of the world, e.g. to your camcorder.

#### **The internal IEEE-1394-connector**

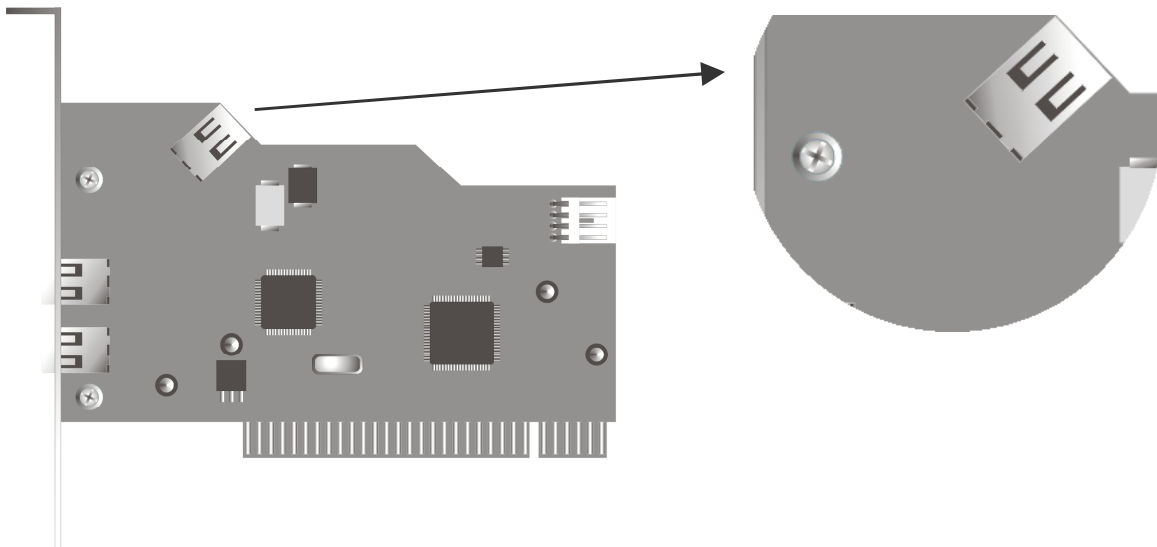

The internal connector of your Cameo 600 DV is intended to connect the 5,25" front panel "Cameo Connect".

## The internal power supply

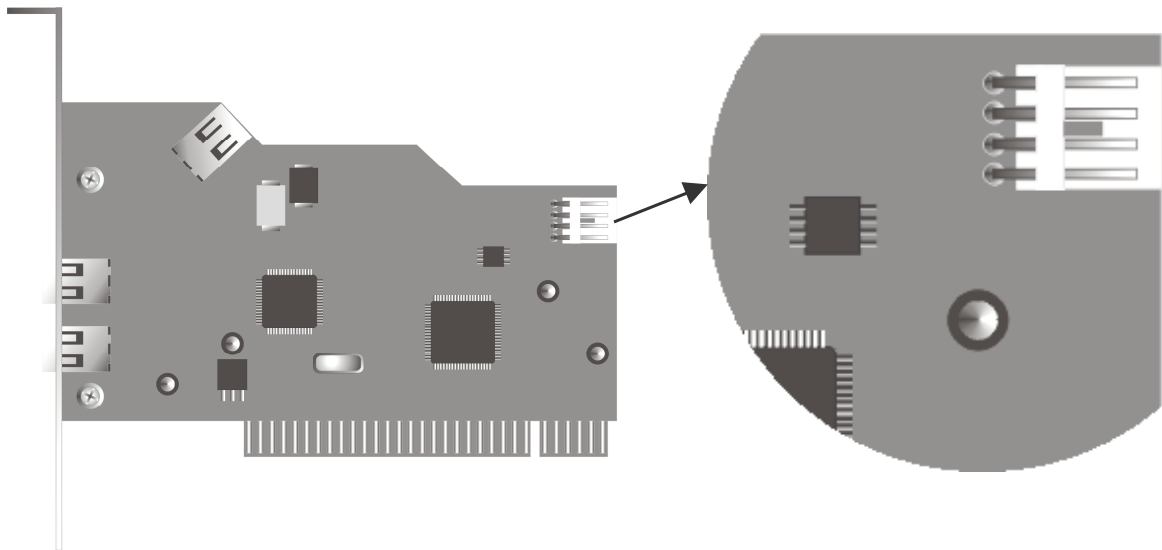

If you wish to connect further IEEE-1394 components, which need to receive their power supply via the Cameo 600 DV, you should connect your computer's power supply directly to the Cameo 600 DV. This way, the power is provided by the power supply, so that the main board, which otherwise conducts the current, will not be overloaded.

Please be careful, when connecting the power adapter to your Cameo 600 DV, as an incorrect connection may damage the product and other components of your system. For more information, please refer to page 8.



---

## ***Installing the Cameo 600 DV – PCI card***

Before installing the Cameo 600 DV into your computer, please pay attention to special features of your computer's configuration. Read the instruction manuals of your computer and other additional cards for information about settings.

If you follow the instructions, the installation should be easy.

If you are experiencing any problems, please carefully read the corresponding sections in the manual once again.

First, check if the package is complete.

Minimum contents of package:

1 Cameo DV, PCI-IEEE1394 Controller

1 Cameo Connect, 5¼" Front module (additional spare front screen)

3 Installation CDs

1 IEEE1394 connection cable 6 Pin to 4Pin for connection to your camcorder

1 IEEE1394 connection cable 6 Pin to 6Pin for connecting the Cameo 600 DV to the Cameo Connect

1 Registration card with serial number

1 Instruction manual

Send in your registration card as soon as possible or get registered the via internet on <http://www.terratec.net/register.htm>. This is important for support and hotline.

---

**Safety note:**

Disconnect the power cord from your computer's power supply and the electrical socket before opening the enclosure!



**And now... step by step:**

- Shut down your computer and all connected peripheral components, like printer and monitor. Ensure the power is switched off at the mains supply socket. Leave the power cord connected first, so that your computer is earthed.
- Touch the metal plate on the rear side of your computer to ground yourself and discharge any static electricity. Remove the power cord.
- Remove the cover of your computer.
- Look for a free PCI expansion slot, remove the screw that holds the slot's bracket and remove the bracket. To guarantee the best operation of your Cameo 600 DV, choose a slot that is not next to a card already installed.
- Unpack the Cameo 600 DV – PCI card carefully. Only touch the card's edges, while the other hand should rest on the metal surface of your computer, ensuring that the electrostatic discharge flows into the computer without damaging the card. Never touch the components on the card's surface.
- Adjust the bracket of the Cameo 600 DV to the slot, so that the card's PCI connector exactly fits to the socket of the slot.
- Apply the card to the slot. You may have to use a little force to make sure that it is connected correctly.
- Now attach the Cameo 600 DV with the screw of the PCI slot's bracket.



---

## ***Installation and connection of the Cameo Connect***

For installing the Cameo Connect, remove one of the 5,25" front blanking brackets of your computer's enclosure (A). Existing shielding sheet metal in the expansion slot must also be removed. Push the Cameo Connect module into the free slot (B).

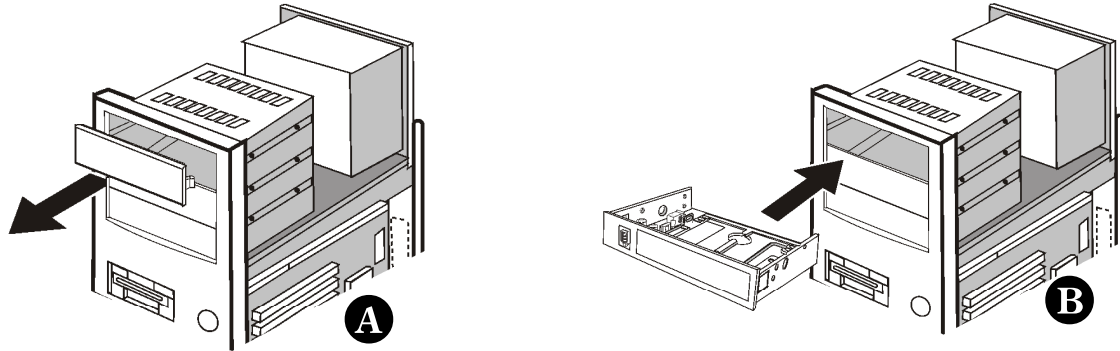

Attach the front module to the computer's enclosure, using the supplied screws.

Connect the internal FireWire™-connector of your Cameo DV PCI-card to the connector of the Cameo Connect front module as shown in the illustration below, using the supplied (short) FireWire™-cable.

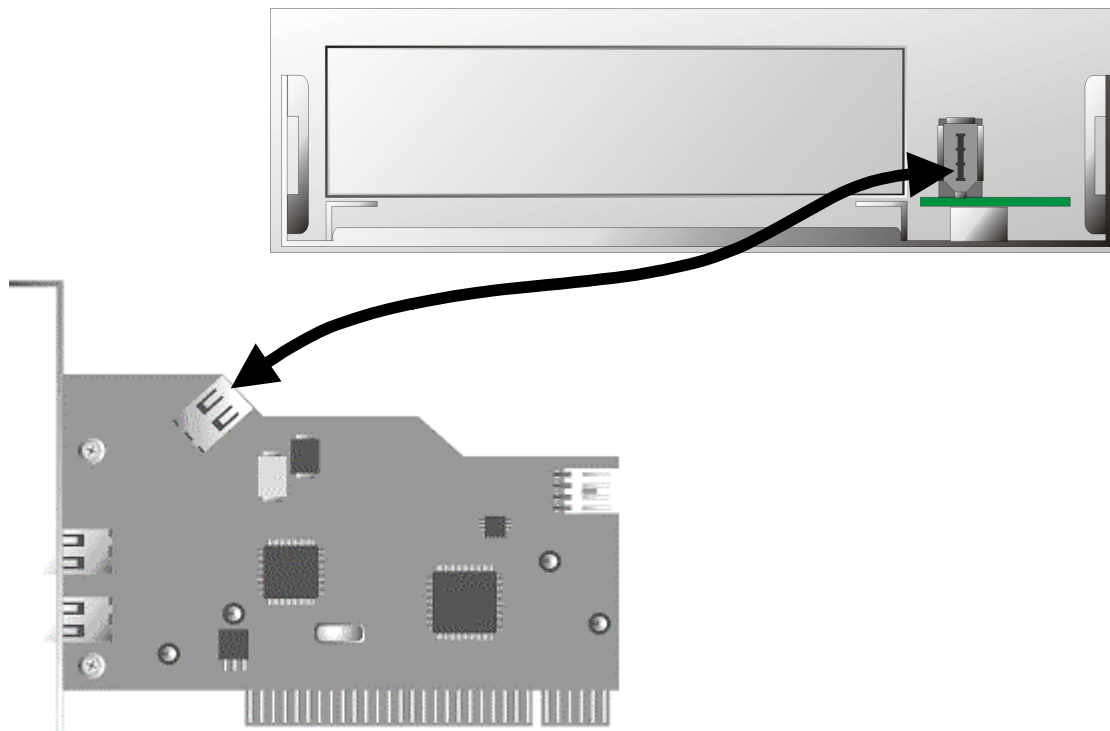

If you wish to connect external components, that do not have an independent power supply, we recommend you connect the computer's power supply to the Cameo Connect. 1. Plug in a power connector of the computer's power supply to the female connector of the supplied Y-cable (see Illustration), 2. Connect the small connector of the Y-cable to the corresponding connector of the Cameo Connect front module.

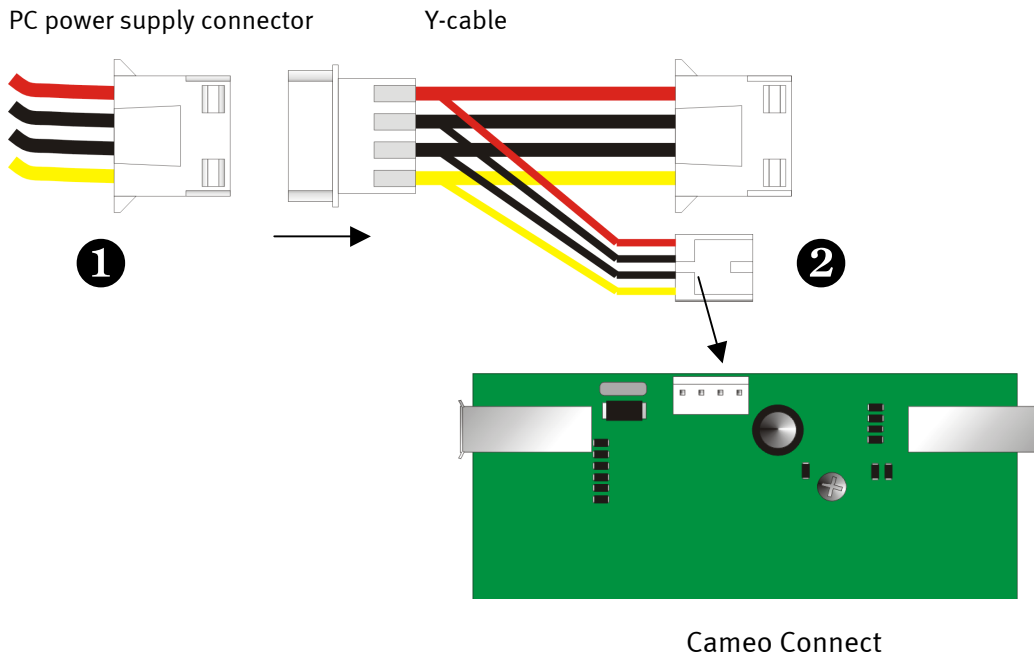

- Re-install the cover.
- Re-connect the power cord and all other cables and restart your computer.

The power connector **MUST** be connected correctly to the Cameo Connect front module, otherwise the module and other components of your system may be damaged.



---

## Connection of a DV – Camcorder

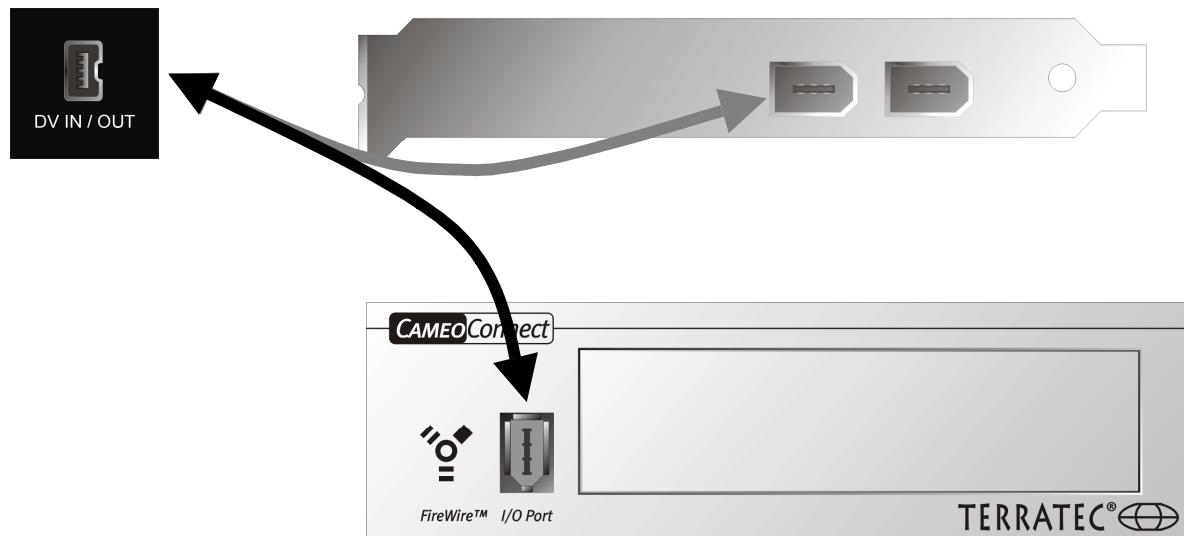

Your camcorder has a female connector, indicated with „DV IN“, „DV IN / OUT“ or „iLink™“ . Apply the smaller connector of the FireWire™ cable to the camcorder's connector and the larger connector to the Cameo PCI card or to the "I/O port" on the front side of the Cameo Connect front module.

## Connection of additional FireWire™-components

In addition to DV camcorders, there are other FireWire™-devices that may be operated with a Cameo 600 DV. These are, for example, FireWire™-hard disk drives, - CD-ROM- or DVD drives, - printers etc. You may connect and operate up to 63 of these devices simultaneously.

**When connecting other FireWire™-components, please refer to the corresponding instruction manuals!**

---

## *Installation of drivers*

If you are using Windows ME or Windows 2000, you may skip this section and continue reading on page 16 (Windows ME) or page 18 (Windows 2000).

Before starting the installation under Windows 98 SE, you should check, whether you are really using the second edition of Windows 98 on your computer. Open the "device manager", proceeding as follows:

Click „Start“ -> „Settings“ -> „Systems Manager“ -> „System“.

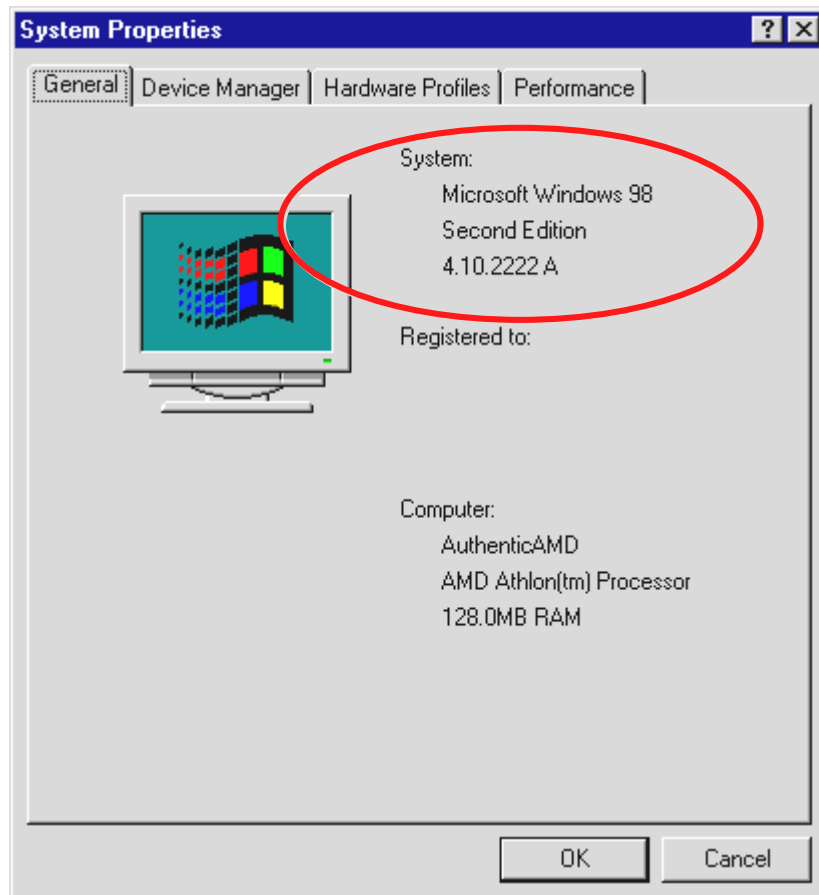

Please note that Windows 98 SE has many improvements in comparison to the first version of Windows 98 and is absolutely necessary for editing DVD videos.

If your system runs with the first version of Windows 98, we strongly recommend you to upgrade to Second Edition. Upgrades from Windows 98 to Windows 98 SE are available at your local retailer and will protect you from major problems, in your objective of performing video editing.

---

## Installation using Windows 98 SE

Disconnect your camcorder from the Cameo 600 DV during the driver installation process.

When you have installed the Cameo 600 DV and have started your computer, Windows 98 SE will automatically detect the card as a new hardware device and will display the following screen.



*Click "Next". The following message will appear:*



*Don't choose any of the options and remove all check marks, which may have already been set. Insert the Windows 98 SE installation CD and again click "Next".*



*If you see the message above, you must tell Windows, where to look for the CD.  
If you click "OK", the next window will appear:*

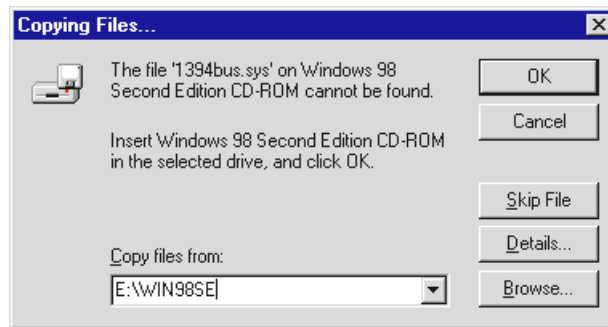

*In the section "Copy files from:", enter the path of the Win98SE folder on the installation CD. (E: in the example above refers to the drive letter where your Windows 98 SE CD is inserted). You may also click "Browse" to search for the file.*



*If Windows has found the necessary files, select "best drivers (recommended)" and click "Next".*

*To complete the installation you should click "Finish" in the final window.*

Windows will now install the drivers for you. This should be all for the moment. However, if you should receive a message, telling you to do something, pressing "Enter" normally is the best thing to do.

After having completed the installation successfully, we recommend you to install DirectX 8.0a and the "Digital Video Update. For more information, read page 19.



### When the drivers are installed.

After having completed the installation successfully, you should check the status of your Windows 98 SE system. Open the device manager to see the installed and detected hardware components of your computer. To open the device manager, select "System" from the control panel and click on "Device Manager"

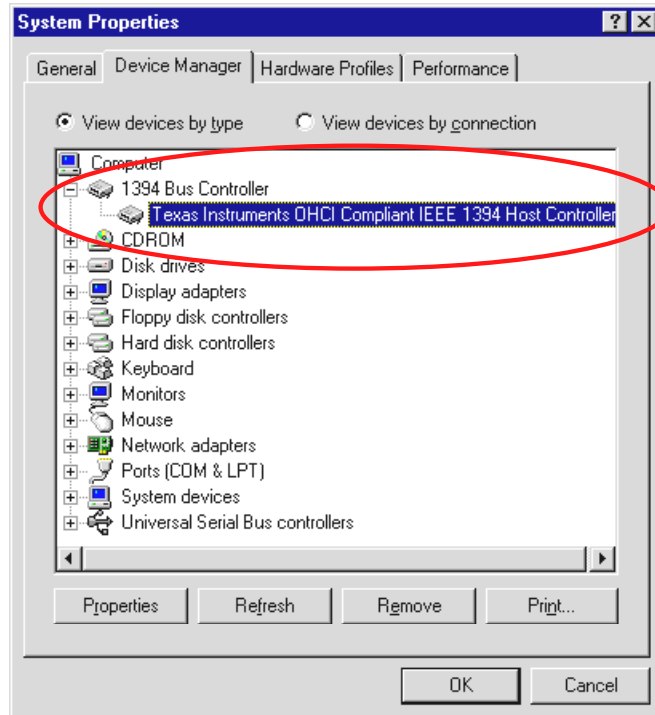

Once the camera is installed and initialised, the Plug-and-Play function will indicate it in the device manager.

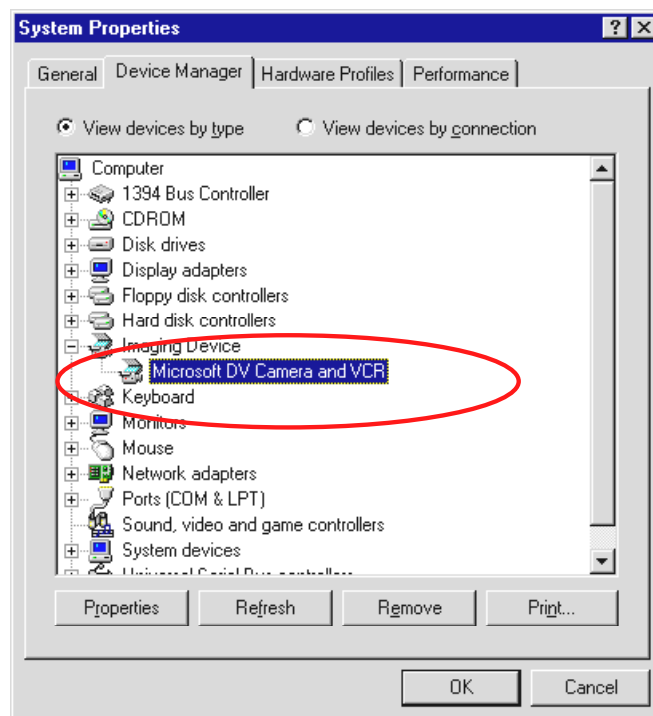

---

## *Installation using Windows ME*

Disconnect the camcorder from the Cameo 600 DV during the driver installation process.

Once you have installed the Cameo 600 DV PCI card and re-started your computer, Windows ME will automatically detect the card as a new hardware component and display the following window:

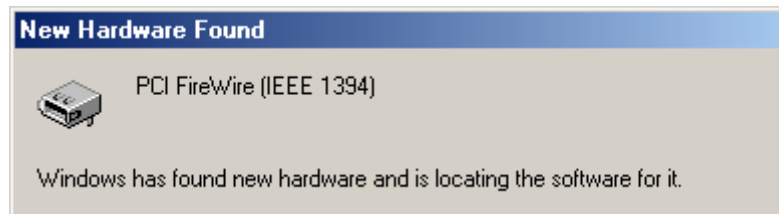

*Next, this dialog window will appear.*



Click "Next" and the following window will be displayed:

*To complete the installation, click "Finish".*

Windows will now install the drivers for you. This should be all for the moment. However, if you should receive a message, telling you to do something, pressing "Enter" normally is the best thing to do.

After having successfully completed the driver installation, we recommend you install DirectX 8.0a and "Digital Video Update". For more information, read page 19.





---

### When the drivers have been installed.

After the driver installation has been completed successfully, you should check the status of your Windows ME system. Open the "Device Manager" to see all installed and detected hardware components of your computer. To open the device manager, click "System" at your control panel and select "Device Manager".

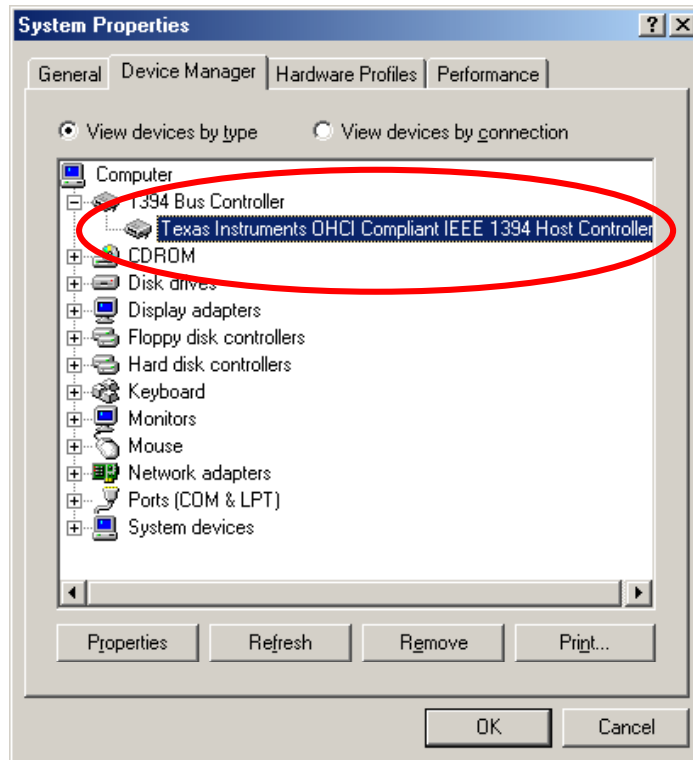

Once you have connected and started your camera, the Plug-and-Play function will indicate it in the device manager.

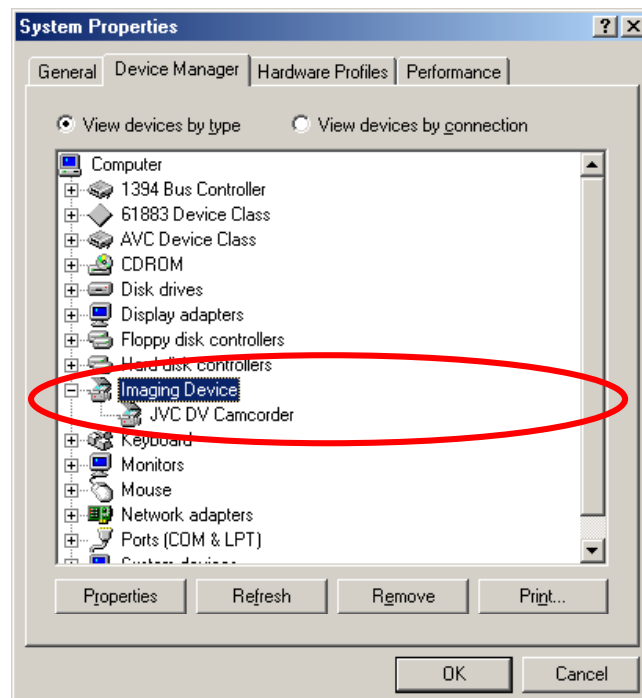

## Installation using Windows 2000

Disconnect your camcorder from the Cameo 600 DV during the driver installation process.

Windows 2000 offers the easiest installation, because all components which are necessary for DV editing, are already available. Drivers will be installed automatically without any requests.

After having completed the driver installation successfully, we recommend you install DirectX 8.0a and "Digital Video Update". For more information, read page 19.



Check the installation once more in the device manager of Windows 2000.

Click "Start ->Settings ->System Manager -> System" and select the registry "Hardware" followed by "Device Manager".

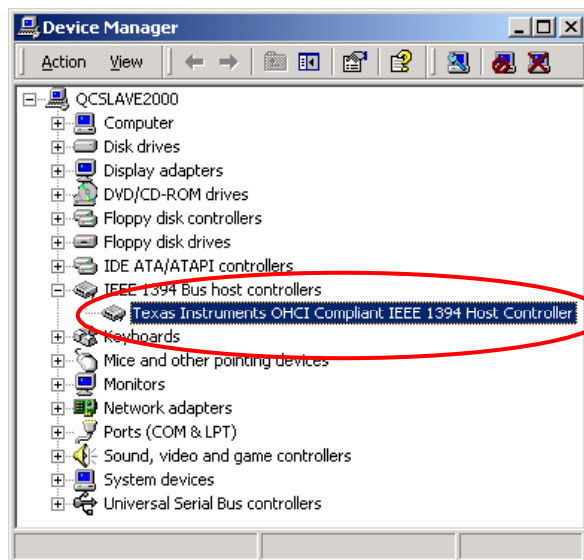

When you have connected the camcorder it will appear in the above list under "Imaging devices"

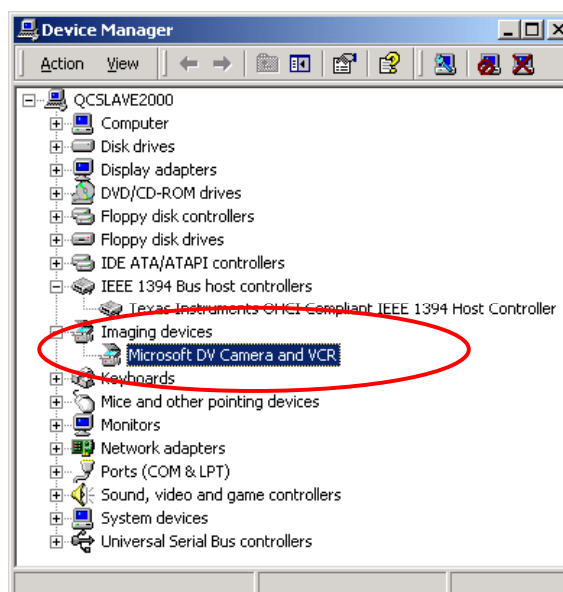

---

## ***Software installation***

Inserting the "Cameo 600 DV –CD1" will automatically start the setup utility. If not, start the program **AUTORUN.EXE** manually in the main folder of the CD.

The setup utility will do a lot of the work for you. However, it cannot all be done automatically. For a complete installation, some points still must be considered.

### ***Installation of DirectX 8.0a and Digital Video Updates – CD 1***

As often in the beginning, some things don't seem to work the way we want them to. With DirectX 8.0a and Digital Video Update, Microsoft offers many improvements and patches, which are absolutely necessary for digital video editing. Please install the updates first!

### ***Installation of MediaStudio Pro 6.0 VE – CD 1***

After the installation of DirectX 8.0a and the "Video Capture Update", please install MediaStudio Pro 6.0 VE. We recommend you to install the Media Studio Pro 6.0 VE next, as further installations from this CD need Media Studio Pro 6.0 VE. The DVD Plug-in will be installed automatically

### ***Installation of Adorage Magic - Volume 1 – CD 2***

The Adorage Magic – Volume 1 effect package must be installed after the installation of Media Studio Pro 6.0 VE, as the effects will be integrated into Media Studio. Inserting the CD will automatically start the setup utility, which will guide you through the installation process. If it doesn't run automatically, start the program **AUTORUN.EXE** manually from the main folder of the CD.

### ***Installation of Cool 3D 2.5 – CD 3***

Insert the third CD to install Cool 3D 2.5. Inserting the CD will automatically start the setup utility. If not, start the program **AUTORUN.EXE** manually from the main folder of the CD.

---

## ***Software overview***

This manual is intended to guide you through the hardware installation process. The following software overview cannot be a complete manual. For more detailed information on the bundled software titles, refer to the documentation on the corresponding installation CD.

### ***MediaStudio Pro 6.0 VE***

The software package Media Studio Pro 6.0 VE consists of the following modules, which will all be installed on your hard disk drive.

- Audio Editor 6.0  
(For editing sounds, fade in/fade out/ increase/decrease volume etc.)
- Video Capture 6.0 (For video recording)
- Video Editor 6.0 (For cutting, editing and reproducing your video cut scenes)

### ***Ulead DVD Plug-in***

The Ulead DVD Plug-in allows you to create Video CDs, Super Video CD's or DVD's of your own videos. You don't need any experience. Ulead DVD Plug-in will guide you through all the important steps. The DVD Plug-in will be installed automatically with the installation of Media Studio and therefore needs no separate installation.

### ***Adorage Magic – Volume 1***

The Adorage Magic effects package will be installed as a so-called Plug-in for Media Studio Pro, offering additional effects in the Media Studio Pro production folder under "Transition Effects".

### ***Cool 3D 2.5***

Cool 3D includes extensive tools for complex and animated 3D titles. The created titles can be laid out as pictures or films and be integrated in your video projects.

## First cuts

Important note! As computer systems usually aren't working seamlessly and system "crashes" can be very annoying, we recommend you save your work frequently, especially after extensive changes have been made. You should get used to this procedure to prevent data losses in case of a system "crash".



### DV recordings with Video Capture 6.0.

This section will give you a short introduction to the work with Video Capture.

1. Connect the end of your DV cable to the Cameo 600 DV.
2. Start your camcorder and set it to Player or VIR-mode. Next, connect the other end of the DV cable to the camcorder. Your system will automatically detect, that your camcorder has been connected to the computer.
3. Start "Video Capture 6.0 from the program folder „Ulead Media Studio Pro 6.0 VE“.
4. First, you must configure some settings in the "Configuration" menu:
  - Choose "Ulead DirectShow recording Plug-in" from the menu "Change recording Plug-in..."
  - Select "Microsoft DV Camera and video recorder" from the menu "Ulead DirectShow recording Plug-in."
  - Select "Device control MS 1394" from the menu "Device control".
5. Select "Preview" from the "View"-menu. Your camcorder should now be remote controlled by the control buttons of "Video Capture, and the picture from your camcorder should be displayed in "Video Capture". If it doesn't support the remote control, you must use the buttons of your camcorder.

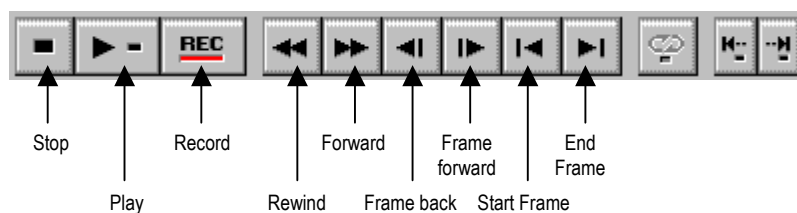

*The Video Capture control section.*

6. Now position your videotape to the point, from where you wish to start the recording and click on the record button "REC" in the Video Capture control section.
7. Now, the window "Cut Video" will open. Select "File" and enter a name for your video clip to be saved on the hard disk drive. You may determine a path for your file, using the "Browse" button. Be sure to have enough free memory, as each second of DV video requires approximately 3,5 MB on your hard disk drive. To start the recording, click "OK".

- 
8. The video data will now be transferred from the camcorder to the hard disk drive in your computer. Don't worry, if the picture shown on your monitor seems to be jerky. This is just a preview and does not influence the final result.
  9. End the recording after a few seconds by pressing the "ESC" button. Your first video clip is now stored on your computer and ready to be edited.

Process the steps described above a second time to collect enough material for the steps described in the next chapter. Be sure to use different names for the two video files. Otherwise the second recording will overwrite the first.

It is recommended to use obvious and explicit names for your video recordings, as this makes it easier to find and sort them later.

## DV cuts with the Video Editor.

Close Video Capture and start the Video Editor. Here, all video clips can be edited. You may also add titles and effects.

The user interface is separated into the following sections:

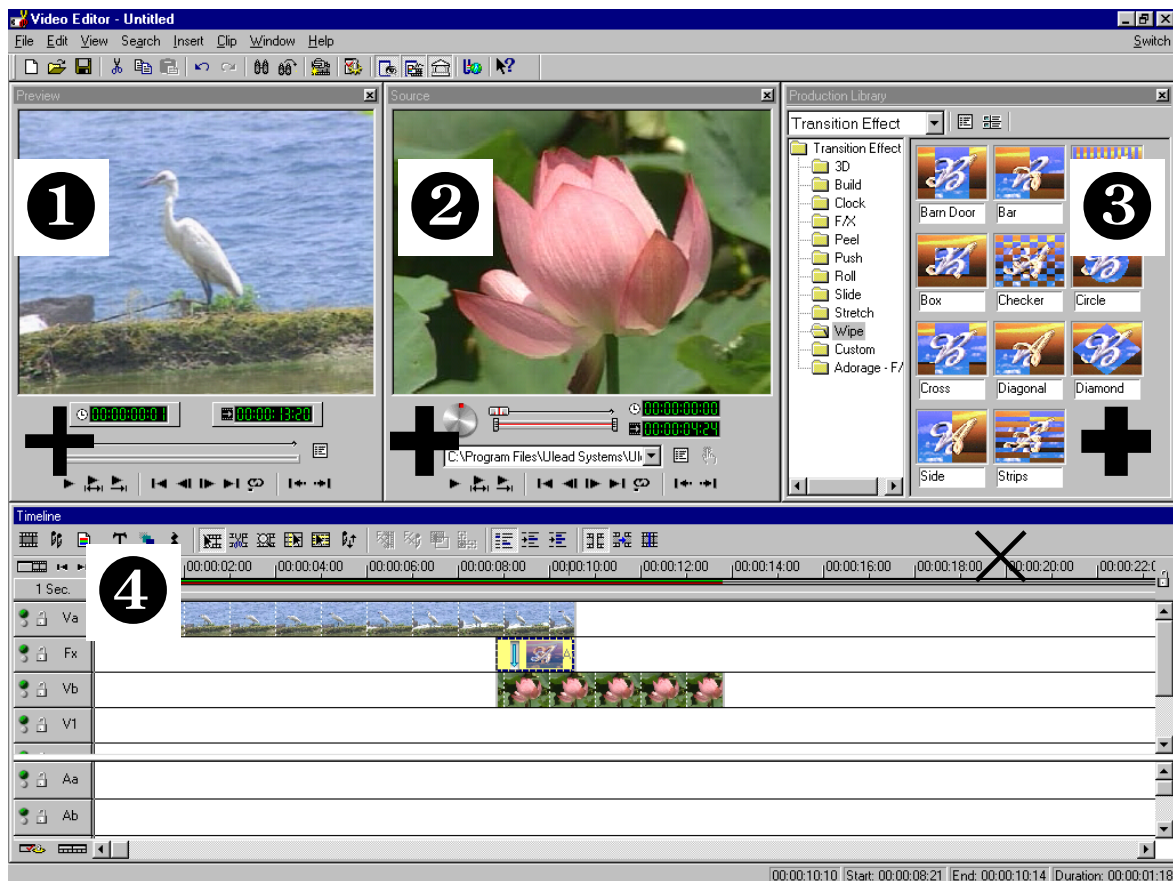

1. Preview window for a preview of your project (in diminished quality)
2. Source window (for cutting video and audio clips before inserting them.)
3. Production library (offers all necessary tools. Video effects, filters and audio effects as well as a library for your video and audio material).
4. Time line (the time line offers a complete overview of your project. All video clips, effects and audio tracks etc, are sorted in a chronological order, from left to right).

### Getting started:

- After having started the Video Editor 6.0 you will have to define your project settings. Choose here

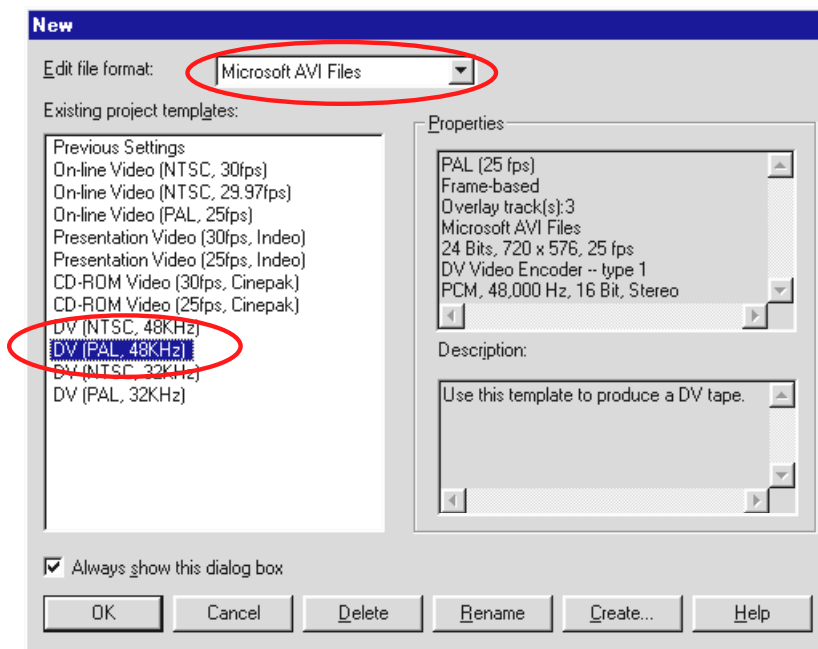

- Next, double click video track Va, which is found in the time line.
- Select your first video clip from the opening file window.
- You can see, that the clip has been positioned on the timeline.

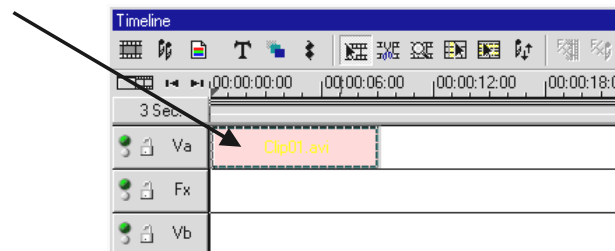

*View the video clip by clicking the "Play" button.*

- Double click on video track Vb and insert your second video clip
- Use the mouse to push the second video clip to the right, so that the beginning of the second video clip slightly overlaps the end of the first video clip.

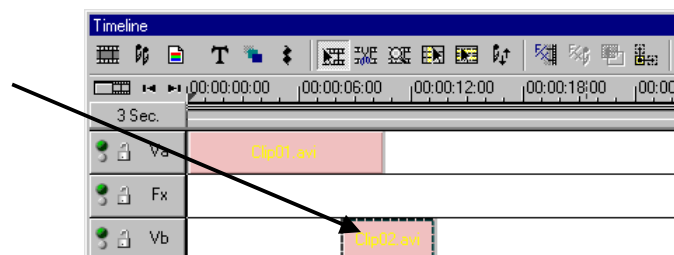

Now look at the preview. You will see, that, from the point, where video clip on Vb overlaps the video clip on Va, only Vb can be seen, and Va seems to have been cut off. This is your first hard cut.



---

## Transition effects

Hard cuts are the most frequently used, but you may also create a more elegant transition from one clip to another.

- Look for transition effects in the **production library**.
- Select the group **Adorage –F/X**.

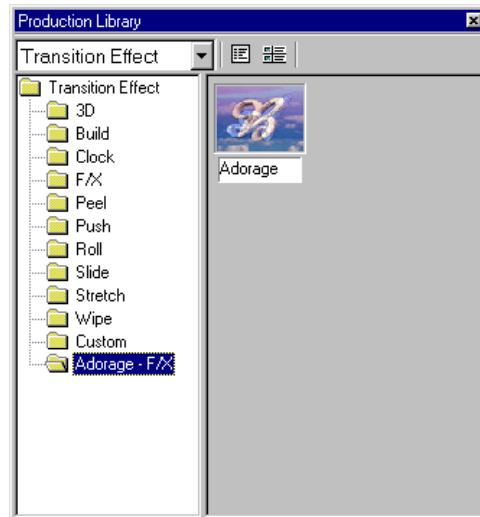

- Use the mouse to move the Adorage icon from the right side of the production library to the Fx track on the time line to the point where your video clips overlap
- The overlapping section conforms to the length of the transition effect.

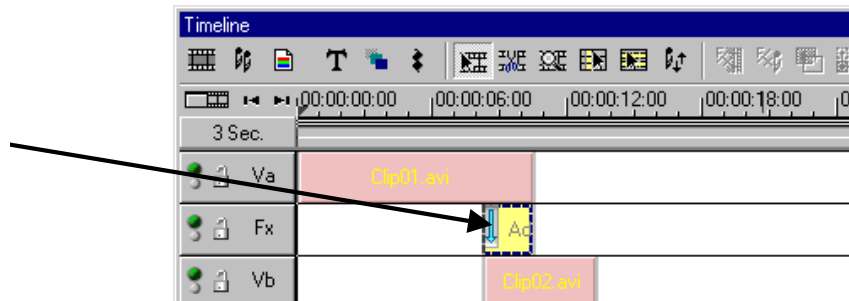

- Double click on the transition effect in the time line to configure the effect settings.  
(For detailed information about effect settings, read the Adorage Magic documentation).

If your camcorder is connected to the Cameo 600DV, you will see no preview in the preview window. The preview will be reproduced directly on the camcorder. To view the video in the preview window, simply disconnect the camcorder.



---

## ***DV transmission to your camcorder.***

When you have finished your first project, you may transfer it back to your camcorder (In this case, your camcorder's DV input must be activated).

1. Connect one end of your DV cable to the Cameo 600 DV.
2. Start your camcorder and set it to Player – or VIR mode. Connect the other end of the DV cable to the camcorder. Your system will automatically detect the camcorder's connection to the computer.
3. Start the „Video Editor 6.0“ from the program group „Ulead MediaStudio Pro 6.0 VE“.
4. Open the video project that you want to transfer to your camcorder.
5. Select "File" in the "Video Editor. Next, choose "Device control"
6. Make sure that "MS 1394 Device control" has been selected.
7. Select "File" again, followed by "Transmit to tape" and choose "Time line".
8. Select "Whole Project" and click on "Options". Choose "Device control" and confirm your entries by clicking on "OK". The transmission to your camcorder will now be started automatically

If your computer does not use a Intel® Pentium® III 500-Processor or higher, audio recordings may cause problems, while the "Transmit to tape" feature for DV camcorders is used. We recommend you to convert the whole project to a single DV video clip. After recording a video from a DV camcorder, the audio section must possibly be calculated again.



## Using the DVD Plug-in.

If you wish to record videos on VCD, SVCD or DVD, they must be in MPEG format and must have a specified resolution. The following chart will help you to prepare your videos according to these requirements.

| Media | Resolution | Framerate | Data rate Video                                  | Data rate Audio                                   |
|-------|------------|-----------|--|---|
| DVD   | 720 x 576  | 25 fps    | MPEG-2<br>4~8 Mbps Constant or variable Bit rate | Stereo, 48 kHz and<br>192~384 kbps<br>MPEG Audio  |
| SVCD  | 480 x 576  | 25 fps    | MPEG-2<br>Variable Bit rate up to 2600 kbps*     | 32~384 kbps*<br>MPEG-1 Layer 2                    |
| VCD   | 352 x 288  | 25 fps    | MPEG-1<br>Constant Bit rate 1152 kbps            | Stereo, 44.1kHz and<br>224 kbps MPEG-1<br>Layer 2 |

\* Attention: The maximum overall data rate (audio and video) must not exceed 2750 kbps.

Open the Video Editor to save your video project in the corresponding format.

1. Load the video project, of which you want to create a VCD, SVCD or DVD.
2. Next, open the "File" menu and select "Create" and "Video File".
3. In the following window, enter a name for the file to be created. Select "File type" and choose "MPEG files" (\*.mpg)\*
4. Click on "Options".
5. In the following window choose "Type of media" and select the corresponding MPEG format. Make sure you set the right video standard of your video project (PAL/NTSC).
6. The Video Editor will now create the corresponding file.
7. After the file has been created (which may take a while in case of longer videos). Click on "File" again. Select "Export" followed by "DVD Plug in"
8. Now choose the file that you have just created: The DVD Plug in will detect the format (VCD/SVCD/DVD) automatically and guide you through the creation of your VCD, SVCD or DVD!

We hope you will enjoy using this product!

---

## ***Appendix***

### ***FAQ – Frequently Asked Questions and their answers***

***Recording video data from the Media Studio Pro 6.0 VE with your DV-camcorder using Windows 98SE does not work as described in the Chapter "DV reproduction on your camcorder."***

1. You probably you haven't activated your camcorder's DV-In feature or you haven't installed DirectX 8.0a. DirectX 8.0a and the "Digital Video" Update are included in the installation CD.
2. Check the DirectX website frequently for updates.

<http://www.microsoft.com/directx>

***I heard that the file size of videos is a problem. Is that true?***

There are indeed limitations to the file size. One reason is the AVI format itself. The AVI format is supported by older VFW-based Software only to a file size of up to 2GB . Current programs, based on DirectShow, support AVI files up to 4GB. As this also only supports a maximum DV video length of 18 minutes, the format has been enhanced. The current OpenDML-format has no limitations apart from the file size of the corresponding operation system.

- FAT (Windows 98 SE, ME, 2000)

Maximum file size is 2GB (approximately 9 minutes of DV video)

- FAT 32 (Windows 98 SE, ME, 2000)

Maximum file size is 4 GB (approximately 18 minutes of DV video)

NTFS (Windows 2000)

The maximum file size depends on the partition size.

If you wish to edit longer videos, we recommend Windows 2000 as an operating system. Media Studio Pro 6.0 VE of course supports open DML files.

---

***Recorded videos are jumpy and jerky.***

Most probably your hard disk drive is too slow and cannot write the transmitted data fast enough. We recommend you de-fragment your hard disk frequently. If you are using an Ultra DMA hard disk, be sure that the Ultra DMA mode is activated in the device manager. Check if there is an IRQ conflict between the Cameo 600 DV and any other component in your PC.

We also recommend you use a separate hard disk drive only for your video material. All temporary folders for Media Studio Pro 6.0 VE should also be installed on this hard disk.

Read the next section too.

***Video data is not being recorded and the computer crashes during the recording.***

Make sure that there is no IRQ (Interrupt) conflict between the Cameo 600 DV and any other component in your PC. Open the device manager (by clicking on "Start->Settings->System Manager->System. In the device manager, double click on "Computer" to display the IRQ list of your computer.). If there is an IRQ conflict you should try first to operate the device in another PCI slot. This will solve the problem in most cases. Be sure not to operate the Cameo 600 DV in the first PCI slot (next to the AGP slot of your graphic card), as this slot in most cases uses the same IRQ as the AGP slot.

***What is the required speed of a hard disk drive to avoid dropouts during recordings or reproductions?***

For a seamless transfer of DV video data, you need a hard disk drive with a minimum speed of 3,5 MB/s. We strongly recommend you to use a SCSI- or IDE hard disk drive, which supports the Ultra DMA mode. If you are using an Ultra DMA hard disk drive, be sure to activate this mode in the device manager and to use the updated Ultra DMA drivers for your system.

***Can frequent transfers between the computer and the camera reduce the quality of video material?***

No! The video material is already available in digital format and doesn't need to be changed anymore. The transmission process between camera and computer can be best compared to a digital copy procedure.

***In Video Capture, I get the message that the drivers for recordings can't be found and recording is impossible.***

Check whether the camera is indicated in the device manager of Win 98 SE/ME or 2000. This procedure is automatically initiated by the operation system. Cameras are indicated as MS Camcorder in the group "Imaging devices". If not, click on "Update".

---

***The camera can be controlled, but there is nothing on the monitor.***

Check, whether the "Ulead DirectShow-capture Plug-in" has been selected in the preferences of "Video Capture". If there is another VFW based interface for video recordings (graphic card, TV card etc.), Video capture may be set to this interface.

***In the Video Capture preview on the screen, the picture is already destroyed and looks like a mosaic. Even after the recording, the picture shown, for example in the Media Player looks the same way.***

Install DirectX 8.0a and the Digital Video Update from the supplied installation CD. Without DirectX 8.0a and Digital Video Update, some PAL camcorders are still detected as NTSC models, which leads to a false interpretation of the video data and to mosaic effects.

***While trying to export a rendered clip, I get the message, that the cassette is write-protected or that a recording is impossible.***

Some cameras have problems, indicating their status correctly when they are using a FireWire™ interface. Remove the cassette from the camera and tape the holes on the rear side with two small tape strips.

---

## ***The perfect computer***

Sorry, but the perfect computer hasn't been built yet. Every computer has its advantages and drawbacks and should be conceived for a primary purpose. We have put together a little list to make the choice a little easier for you.

### **The CPU**

For working with DV video data, the processor's speed is secondary, but will be relevant, if you want to create video effects and complex transitions. A faster processor will decrease the effect calculation time and the time you have to wait. For video editing, we recommend Intel Pentium III, AMD Athlon or, of course, faster!

### **The main memory**

If you are editing videos, the video material must be manipulated. When large amounts of data can be held in the memory and don't need to be read from the hard disk drive all the time, the advantages are obvious. Though 64MB Ram is enough, we recommend you use a main memory of 128MB. If you are using Windows 98 SE an extended main memory is useless. For Windows ME and Windows 2000, we recommend 256MB.

### **The hard disk drive**

The most important component for video editing! An up to date hard disk should usually be able to read and write data fast enough. If you are using an IDE hard disk, make sure that it is in DMA mode. We also recommend you to use an additional hard disk, which is only used for video data.

---

## *You're not alone ...*

We have put together this list of Internet links, which are hopefully of interest.

### **Links of camcorder Producers:**

#### *Canon*

- Germany - <http://www.canon.de>
- England - <http://www.canon.co.uk>
- France - <http://www.canon.fr>
- Italy - <http://www.canon.it>
- Spain - <http://www.canon.es>
- Netherlands - <http://www.canon.nl>

#### *JVC*

<http://www.jvc-europe.com/JvcCons/>

#### *Panasonic*

- Germany - <http://www.panasonic.de>
- England - <http://www.panasonic.co.uk>
- France - <http://www.panasonic.fr>
- Italy - <http://www.panasonic.it>
- Spain - <http://www.panasonic.es>
- Netherlands - <http://www.panasonic.nl>

#### *SONY*

- Germany - <http://www.sony.de>
- England - <http://www.sony.co.uk>
- France - <http://www.sony.fr>
- Italy - <http://www.sony.it>
- Spain - <http://www.sony.es>
- Netherlands - <http://www.sony.nl>



---

The following companies are offering activators for DV camcorders (to enable the DV-in feature):

<http://www.como.com>

*Germany*

<http://www.dv-in.de>

<http://www.dvicut.de>

<http://www.hifivideofachversand.de>

<http://www.stonehead.de>

*Netherlands*

<http://www.twintek.nl/dvwidget.html>

<http://enable.dvin.org/>

*UK*

<http://enable.dvin.org>

Further links for digital video editing:

<http://www.dvfilmmaker.com> (Site in English dealing with DV video topics)

<http://www.mainconcept.com> (Producer of video cutting and composition programs as well as further useful software)

<http://www.videox.net> (Site in German)

<http://www.slashcam.de> (Site in German)

---

## ***TerraTec service.***

Even the best systems may experience problems or breakdowns. In this case, the TerraTec team will be pleased to help you.

### **Hotline, Mailbox, Internet.**

In case of bigger problems, that cannot be solved alone, with the help of your retailer or this manual, contact us directly.

The Internet is the first way to look for help: Visit <http://www.terratec.net/> , where you find current answers to frequently asked questions (FAQ's) as well as up to date drivers, all available in our mailbox system. Phone numbers are: **+49- (0) 2157-8179-24** (Analog) and **+49- (0) 2157-8179-42** (ISDN).

If this still doesn't help you, please refer to our telephone hotline. You may also contact us online, visiting this page: <http://www.terratec.net/support.htm> . In both cases, keep the following information available:

- Your registration number,
- This instruction manual,
- A printout of your configuration files,
- The manual of your motherboard,
- A printed screenshot of your BIOS configuration.

It would also be good for you to sit next to your computer while calling our technicians, in order to try out some of the hints immediatly. We strongly recommend you to note the name of the technician, when contacting our support team. You need this name, if your card is defective and must be returned.

### **Broken?!**

**Contact** us, before your card is returned to us, note the name of the support technician and pay attention to the following points:

- Fill out the service card that comes with your product, completely and explicitly. The more detailed you describe the problem, the quicker it can be handled. Contributions without a description of the problem cannot be forwarded and will be returned at your expense.
- We strongly recommend you also send in a copy of the receipt or bill (not the original). If there is no copy included, we assume that the guarantee time has run out and will repair the card at your expense.
- Please use a safe and appropriately protective package. Goods damaged in transit cannot be repaired by us under warranty. Experience has shown, that the original package serves best for this purpose. Remember that your card is a fragile and sensitive electronic part.
- Put an appropriate postage on the package, just as we do, when returning your card..

---

## General service regulations

### 1. General

With the purchase and the receipt of the product you accept our general service regulations

### 2. Proof of guarantee

To verify your proof of guarantee, we recommend you send in the receipt, bill or delivery note. Without any proof of guarantee we will repair the product at your expense.

### 3. Description of problem

Contributions without a description or with an incomplete description ("defect" or "to be repaired") will be returned and a fee will be charged as, this additional complication could have been avoided.

### 4. Invalid returns

In case of Invalid returns ( no fault found, probably operational error), we will return the product and charge a fee.

### 5. Package

Please use the original package, when returning the product to us. Improper packing will endanger the warranty claim. Damages resulting from poor packaging during transport will invalidate the warranty claim.

### 6. Foreign manufactured products

Products that have not been manufactured or distributed by TerraTec Electronic GmbH, will be returned and a fee will be charged.

### 7. Repairs liable to your expense

Repairs out of the warranty period are liable to your expense.

### 8. Transportation costs

The sender is responsible for the costs for transportation and insurance of products sent to TerraTec Electronic GmbH. In case of warranty, TerraTec is responsible for the costs of returning the product to the customer. Packages with no postage will be returned due to organizational reasons.

### 9. Final regulation

General service regulations of TerraTec GmbH are subject to changes without notice.

In all other respects the general trading conditions of TerraTec GmbH are considered as accepted.

---

## **Glossary**

**Activation** – Due to the European customs regulations, the import of digital video recorders is more expensive than the import of digital video playback devices. For this reason, manufacturers of camcorders have started to modify their products for the European market by disabling the DV input. Some smart developers didn't take long to find ways to remove this limitation. This procedure is called "Activation". This activation is required to transfer video material from external sources to a DV camcorder. Activators are available for almost all types of camcorders, and can be bought legally at your retailer.

**AVI** – A Windows video format.

**Bitrate** – Indicates the amount of a data transferred per second. The higher the bit rate, the better the quality. There are two types of bit rates: Constant (e.g. for -> VCD) and variable (e.g. ->SVCD and -> DVD). In contrast to the constant bit rate, the variable bit rate is aligned to picture material.

**Blue Screen** – A Variation of -> Chroma Keying

**Capture** – Another word for recording.

**Chroma Keying** – Chroma keying uses a mono colored surface, to record , for example, an actor in front of it. When the recorded video is edited, the mono colored surface may be replaced by another background.

**Chrominance** – Chrominance indicates the color signal in ->YUV, which consists of two color components. U is the balance between red and cyan, while V is the balance between yellow and blue.

**Clip** – A small piece of video material.

**Color saturation** – Indicates the amount of color in a picture.

**Composite Video** – Composite Video is a transmission process used in the consumer section. It is processed over a cinch connector and is often used with TV sets. In this procedure, all signals (chrominance and luminance) are transmitted with only one cable. The Composite Video's quality is worse than, for example, in -> S-Video, where chrominance and luminance are transmitted separately.

**CPU** – Central Processing Unit. The part of your computer that actually calculates (I. E. Pentium or Athlon)

**D8** – Digital 8 is the successor of Hi8 or the VHS-C format for camcorders. Though it is still recorded on Hi8 or D8 cassettes, it uses a digital DV format.

---

**Data flow rate** – see Data transfer rate

**Data transfer rate** – the data transfer rate indicates, how fast your hard disk drive can read or write continuously. The data transfer rate is measured in megabytes per second, e.g. 7 MB/s.

**Device control** – Indicates the possibility to control your DV camcorder from the computer.

**DirectDraw** – DirectDraw is a graphical standard initiated by Microsoft. Among other features it enables data to be written directly to the graphic card's memory space, to allow e.g. a seamless video display.

**Dropped Frames** – these are missing pictures in the video data flow, mainly caused by slow hard disk drives.

**DV** – DV is the abbreviation of Digital Video. The DV standard has a compression procedure of 5:1, which corresponds to a data rate of 3,125 MB/s and therefore can be handled by almost every hard disk drive. The DV quality standard is very high and is often used in professional productions. There are two types of DV cassettes, which differ in size and maximum play length, while their video data is compatible to one another. Mini DV is mostly used in the consumer section and offers tapes with a length of up to one hour. The DV format for professional use offers play lengths of up to three hours.

**DVD** – DVD is the abbreviation of Digital Versatile Disk. The diameter is the same as of a standard CD-ROM. At the moment, memory capacities from 4,7GB (DVD-5) to 17GB (DVD-18) and data rates from 600 to 1300KByte/s are specified. In addition there are various formats, like DVD-Video, DVD-Audio, DVD-ROM, DVD-R, DVD-RW and DVD-RAM.

**DV-In** – The DV connector of a camcorder usually is able to transfer video data in both directions – in and out of the camcorder. However, many of the E European camcorders do not provide the DV input option. See also -> Activation

**FireWire™** – Apple's name for -> IEEE-1394

**Framerate** – Indicates the number of pictures in specific time. Often measured in FramesPerSecond.

**Half pictures** – To avoid flickering when reproducing video signals on a TV screen, 50 half pictures per second are transmitted in stead of 25 whole pictures (in PAL standard. Half pictures are either the uneven lines (transmitted first) or the even lines, displayed on the screen.

**Hi8** – Analog video recording system, transmitting color and illumination separately, allowing a better quality as in example VHS-C.

---

**Hosiden connector** – A small connector with 4 poles to transmit ,in example, -> S video signals.

**IEEE-1394** – Originally a Universal Bus system for digital data transfer, developed by Apple. Devices may be connected by cables with a length of up to 4, 5 m. This system offers data transfer rates of up to 400 Mbits/s. As there's is no specified data format for this system yet, a homogenous standard for video data is still missing. Sony has filled the gap with the "normative strength of the actual", by integrating FireWire™ connectors into their own digital recorders. FireWire™ and the Sony protocol have finally achieved seamless video editing.

**Ilink** – Sony's name for -> IEEE-1394

**Interlacing** – see half pictures.

**Linear Editing** – see Linear video cut

**Linear video cut** – The linear video cut originates in analogue video. Original video data is mostly available in the same order as edited video clips. A simple way of linear cutting is, for example, the transmission from an analogue video camera to a video recorder and the simultaneous erasure of some clips. If you wish to insert, for example, a new video clip at the middle, all following clips must be cut again.

**Luma Keying** – In opposition to Chroma Keying, in Luma Keying the video transparence is determined by the illumination.

**Luminance** – Luminance indicates illumination in -> YUV. (Y)

**Main memory** – See RAM

**MiniDV** – the consumer version of the DV-format. See also -> DV.

**MiniDVD** – Indicates a procedure, where -> DVD data with a corresponding registry structure and a navigation menu is copied to conventional CD. Due to the small memory space, a MiniDVD can only store 18 minutes of video data. Unfortunately, only a few DVD players can play MiniDVD, so that for the creation of a MiniDVD, a reproduction on a computer is recommended.

**MJPEG** – Motion JPEG is a compression procedure, where every picture in the video data stream is compressed individually.

**MPEG** – The Motion Picture Experts Group is a consortium of leading manufacturers and developers of video technology, setting new standards like MPEG-1 or MPEG-2.

**Non-linear Editing** – see Non Linear Video Cut

---

**Non-linear video cut** – In contrast to the → linear video cut, this procedure allows you to edit video clips without influencing the following clips. The non-linear video cut enables you, for example, to shorten a clip at the beginning of a video project without having to edit the following video clips again.

**NTSC** – NTSC is a video standard which is used, for example in Japan or the USA. NTSC offers a higher frame rate than PAL (30 pictures or 60 → half pictures per second, but uses a lower resolution (525 lines, of which 480 are visible). The color display in the NTSC standard is indicated in →YIQ.

**Overscreening** – Indicates the soft effective transition from one video clip to another.

**PAL** – PAL is the most common video standard in Europe. The frame rate of PAL is 25 pictures per second (or 50 → half pictures. The color display in PAL is indicated in →YUV.

**Preview** – the preview offers you a practical overview of your work. The final quality is usually better than the quality of a preview.

**RAM** – Random Access Memory is your computers main memory. Video editing with the use of effects requires a lot of main memory, so: The more RA M you have, the better it is.

**Rendering** – Indicates the re-calculation of video and audio clips, after having changed them, for example, by using filters or effects.

**RGB Color space** – In the RGB color space, every visible pixel consists of the three components R(ed), G(reen) and B(lue).

**Saturation** – see Color saturation

**Screen** – see Overscreening

**Storyboard** – In contrast to → Timeline, the Storyboard offers a topical overview of your video project's order. Individual scenes can be identified easily, with the lack of a relation to the real length of a project.

**SVCD** – Abbreviation for Super Video CD. SVCD resembles a →VCD with the advantage, that the data is available in a MPEG2 format with a → variable bit rate. In addition, the resolution of 480 x 576 pixels exceeds the resolution of a VCD. A SVCD can usually store 45 to 50 minutes of video. The bit rate (audio and video) of a SVCD must not exceed 2,6 Mbps. Most pure DVD players can replay the SVCD.

**S-Video** – In contrast to → Composite Video, chrominance and luminance of the video signal are being transferred separately and therefore offer a higher quality.

**Timeline** – Timeline is a time axis on which you edit and position your video clips

---

**Transition** – See Overscreening

**Trim** – Indicates the cutting of a video at the beginning or end

**VCD** – Abbreviation for Video CD. A Video CD offers a PAL resolution of 352 x 288 pixels and uses the MPEG1 format for saving video and audio data. The VCD uses a constant bit rate of 1,15 Mbps for video and 224 kbps for audio data. Almost every DVD player can replay a VCD.

**Video filter** – Video filters allow you to edit your video material in many ways. You may, for example, use video filters to change colors and use complex filters to decrease the quality of your best videos and let them look like an old silent movie.

**Video for Windows** – A video concept for Windows, aged, but still frequently used.

**YIQ** – YIQ is a color space related to → YUV. It is equally determined by an illumination component → Luminance (Y), but by different color components, called I (Cyan Orange Balance) and Q (Magenta Green Balance). YIQ is, for example, used with → NTSC.

**YUV** – A color space, that is determined by an illumination component (→ Luminance-Y) and two color components (→ Chrominance- U,V).